



LUXURY CRAFTED IN VERONA

THE PRODUCTS

2  
VOLUME



ZB  
*Bruno Zampa*  
LUXURY CRAFTED IN VERONA

# INDEX

## VOL. 01

**INTRODUCTION** ..... 4

### **SOFAS, ARMCHAIRS & COMPLEMENTS**

SOFAS ..... 20  
ARMCHAIRS ..... 96  
DORMEUSE ..... 146  
POUFS ..... 156  
SOFA TABLES ..... 164

### **TABLES & DINING CHAIRS**

DINING TABLES ..... 206  
DINING CHAIRS ..... 248  
BAR COUNTERS AND STOOLS ..... 274

**SUMMARY** ..... 284

## VOL. 02

**INTRODUCTION** ..... 4

### **BEDS & COMPLEMENTS**

BEDS ..... 20  
BEDSIDE TABLES ..... 50  
CHEST OF DRAWERS ..... 64  
DRESSING TABLES ..... 76  
BENCHES ..... 88

### **CABINETS**

CONSOLLES ..... 98  
SIDEBOARDS ..... 120  
TV UNITS ..... 140  
DISPLAY CABINETS ..... 160  
BOOKSHELVES ..... 174  
CABINETS ..... 184

### **OFFICE**

DESKS ..... 214  
OFFICE CHAIRS ..... 222

### **OCCASIONALS & DECORATIONS**

MIRRORS ..... 230  
DECORATIONS ..... 244  
RUGS ..... 256  
LIGHTINGS ..... 266

**SUMMARY** ..... 280

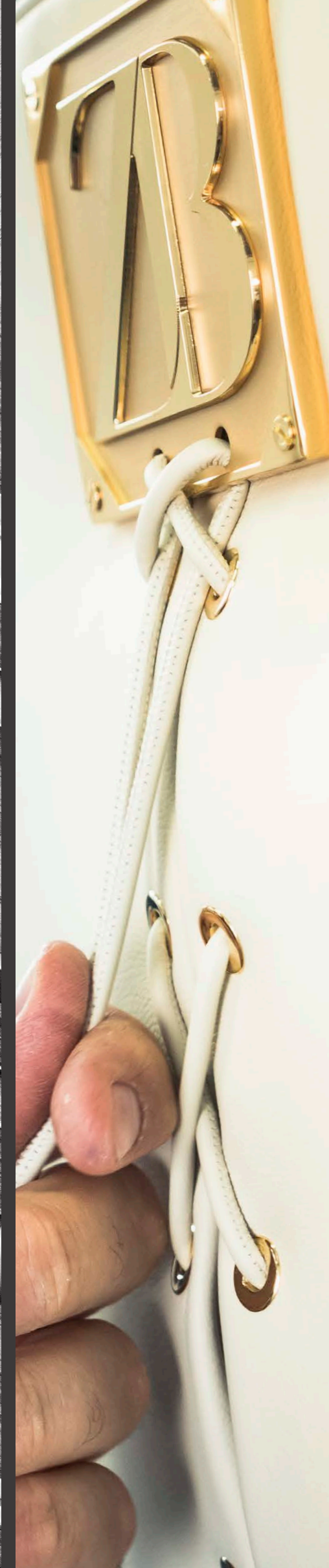

## LUXURY CRAFTED IN VERONA

Luxury is crafted. Not made.  
Luxury crafted by artisans is the most precious.  
Artisans are not all the same.  
That's why our craftsmanship is based exclusively in Verona.  
To thrive on the heritage of Verona's art and lifestyle.

Il lusso è arte manuale. Non è semplicemente prodotto.  
Il lusso realizzato dagli artigiani è il più prezioso.  
Gli artigiani non sono tutti uguali.  
Per questo la nostra maestria artigianale opera esclusivamente a  
Verona. Città custode di un immenso patrimonio artistico e simbolo  
di uno stile di vita esclusivo.

Люкс - это ручная работа, а не простой продукт.  
Люкс реализован вручную мастерами и более ценен.  
Все мастера не похожи друг на друга.  
Именно поэтому наши мастера исключительно из Вероны.  
Где рождается наследие искусства и образ жизни.

奢侈是匠心创造的艺术。而不仅仅是产品。  
匠人所创造的奢侈是最珍贵的。  
而匠人并非各个都一样。  
我们只用维罗纳的匠人。  
因为，这里有独特的生活与艺术底蕴。

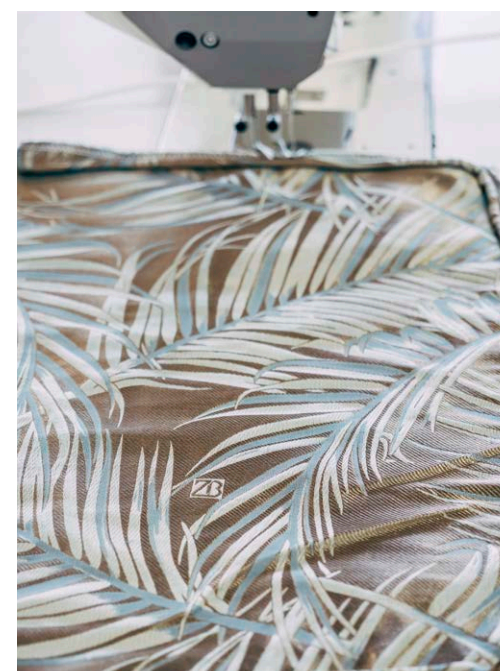



*Bruno Zampa*

Founder, since 1960.



*Ruben, craftsman in Bruno Zampa for 18 years.*



*Anna, final buffer, is checking all the smallest details in our polishing center.*



*Andrea, quality manager, is carrying out the last finishing touches.*



## A RELIABLE PARTNER FOR YOUR BUSINESS



Andrea Zampa,  
General Manager,  
is welcoming clients  
in our Gallery.

Working with custom made Luxury, one wishes to avoid problems or solve them efficiently. That's why Bruno Zampa grants:

- Budget safe approach
- Focus on your custom made project
- Company credibility, unchanged ownership since 1960
- Clever solutions for "impossible" requests
- Reliability beyond legal warranty

Nel settore del lusso e delle creazioni di alta gamma personalizzate, sono necessarie soluzioni efficienti.

Per questo Bruno Zampa garantisce:

- Rispetto del budget
- Focus su progetti personalizzati
- Solidità aziendale, sempre la stessa proprietà dal 1960
- Soluzioni efficaci per richieste "impossibili"
- Affidabilità oltre le garanzie legali

При работе с элитной продукцией, создаваемой по специальному заказу, каждый хотел бы избежать проблемных ситуаций и эффективно справиться с возникающими сложностями.

Поэтому Bruno Zampa предлагает:

- рациональный финансовый подход
- фокус на индивидуальном проекте
- надежность — руководство компании не менялось с 1960 г
- находчивые решения к твоим «невозможным» запросам
- ответственность и юридическую гарантию

选择高端定制，意味着全程无忧的高效解决方案。

这也正是 Bruno Zampa 向您做出的承诺：

- 符合您的预算设定
- 满足您的定制要求
- 卓越公司信誉，自 1960 年起从未易主
- 以最佳方案将“不可能”变为可能
- 以高于法律要求的标准，成为您的无忧选择





*Matteo De Stefani, architect,  
designer of Bruno Zampa collections.*



CUSTOM  
MADE  
FURNITURE  
FOR YOUR  
DESIGN





Bruno Zampa is focused on custom made solutions:

- Extended product range, with 15.950 combinations in materials and finishing
- 43% of our overall production is customized and not in the standard range
- Our creative and technical staff is at customer's disposal to customize products and projects
- The appointed Project Manager will be the only interface to deal with

Bruno Zampa è focalizzata su soluzioni personalizzate:

- Ampia gamma disponibile, 15.950 combinazioni di materiali e finiture
- Il 43% della nostra produzione è su misura
- Il nostro staff creativo e tecnico è a disposizione per la personalizzazione di prodotti e progetti
- Il Project Manager assegnato sarà l'unico riferimento dall'avvio alla chiusura del progetto

Bruno Zampa — это индивидуальные решения:

- широкий ассортимент товаров, 15.950 сочетаний материалов и отделки мебели
- 43% нашей продукции нет в каталоге, так как она персонализирована
- Наш дизайнерский и технический персонал в твоём распоряжении, для того чтобы персонализировать модели и проекты
- У тебя будет проект-менеджер, который будет исключительно в твоём распоряжении

Bruno Zampa 专注于定制解决方案:

- 超细化产品分类, 15.950 种材料和饰面组合
- 43% 的产品都无法在目录中找到, 因为它们都是个人定制的
- 我们的创意团队和专业团队为你提供定制的产品和设计
- 你将会拥有你专属的项目经理

*Mattia, interior designer,  
is creating the project's moodboard*

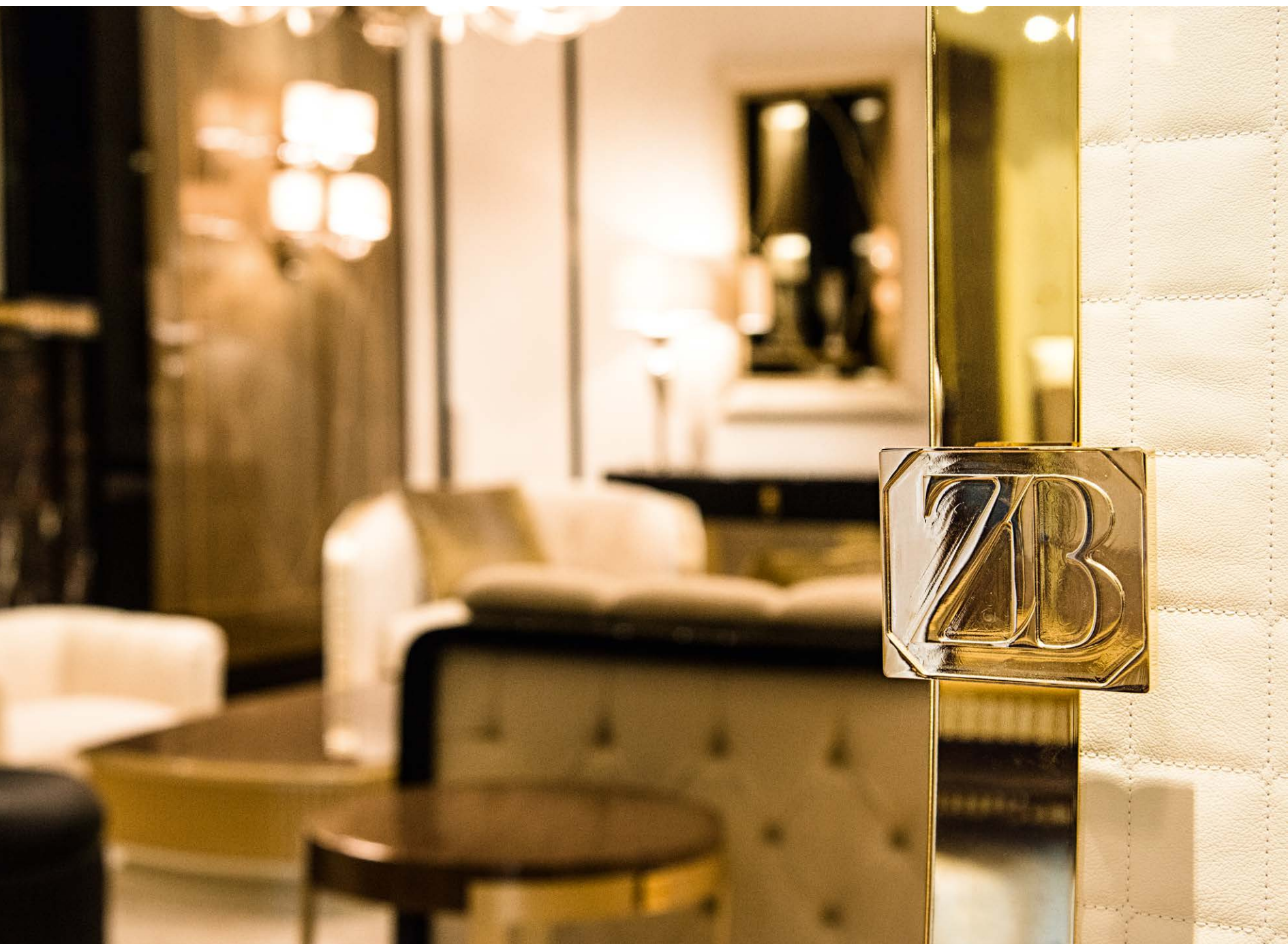

## EXPERIENCE THE CRAFTSMANSHIP: COME TO THE VERONA HUB

Luxury cannot be told.  
One has to touch it, smell  
it and feel it. It can not be  
imagined.

In our Verona HUB  
customers will experience:  
- Our luxury craftsmanship  
at work in our 4 production  
units: joinery, tailoring,  
upholstery, polishing  
- 11 projects in our 1.025 m<sup>2</sup>  
Gallery  
- The meeting with our  
design team

Il lusso non può essere espresso  
con parole.  
Per comprenderlo è necessario  
toccarlo e assaporarlo. Non può  
essere semplicemente immaginato.  
Nel nostro HUB i clienti possono  
vedere e vivere:  
- I nostri artigiani del lusso al  
lavoro nelle 4 unità produttive:  
 falegnameria, sartoria,  
 tappezzeria, lucidatura  
- 11 progetti ambientati nella  
nostra galleria di 1.025 m<sup>2</sup>  
- l'incontro con il nostro team di  
progettazione

Роскошь невозможно выразить  
словами.  
Ее нужно прочувствовать:  
прикоснуться к ней и ощутить  
ее вкус. Не пытайтесь  
представить ее.  
В нашем центре в Вероне вас  
ждет:  
- наше мастерство изготовления  
на деле: столярные работы,  
подгонка, обивка и полировка  
изделий  
- 11 проектов в галерее  
площадью 1025 м<sup>2</sup>  
- знакомство с командой  
дизайнеров

奢侈不可言之。  
您必须触于手，嗅于鼻，感于心。  
而非凭空想象。  
在我们维罗纳的中心，您将体验到：  
- 我们四个制作单位的精湛技艺：  
细木工、剪裁、内饰和抛光  
- 我们 1.025 平方米的展厅，呈现  
11 个特色各异的项目  
- 与我们的设计团队亲自会面沟通



# APOLLO

BED

Struttura in legno massello e multistrati di legno. Testata e giroletto decorati in pelle ricamata. Dettagli in metallo. Imbottiture in poliuretano a quote differenziate. Rete a doghe in legno compresa. Dimensioni previste: queen e king size. Set letto disponibile su richiesta.

Solid wood and plywood structure. Quilted leather bed header and bed frame. Metal details. Multiple densities polyurethane foam padding. Wooden slat included. Available in queen and king size. Bed set available on request.

Каркас из массива дерева и фанеры. Изголовье и каркас кровати отделаны стеганой кожей. Металлические детали. Набивка из пенополиуретана разной плотности. С деревянными ламелями. Доступные размеры: Queen size и King size. Постельное белье можно приобрести по запросу.

实木和胶合板结构。绗缝皮革床头板和床架精细金属配饰。多重密度聚氨酯泡沫填充垫料。含实木板条。可选大号 and 超大号。可根据请求提供床套。



B E D S

As picture: Apollo bed  
In price list: Ambition

Letto e sommier/Bed and sommier/  
Кровать и каркас кровати/床和床垫  
BZ 901-702 LEATHER DOVE GREY

Parti in metallo/Metal parts/Металлическая фурнитура/金属部件  
GOLD  
Trapunta/Quilt/Стеганое одеяло/被子  
BZ 212-1078 SATIN MASTIC

Plaid/Plaid/Плед/格纹  
BZ 215-05 JACQUARD SANDSTONE  
Cuscini/Pillows/Подушки/抱枕  
BZ 212-1078 SATIN MASTIC  
BZ 215-05 JACQUARD SANDSTONE

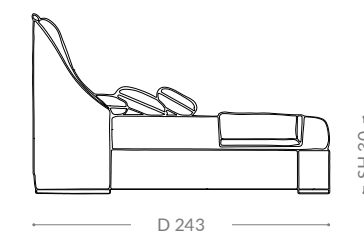
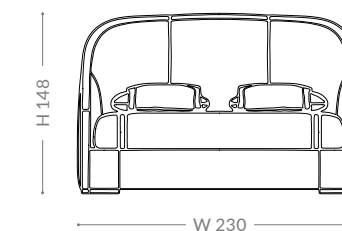

APOLLO King Size  
(Recommended mattress cm 200x200)

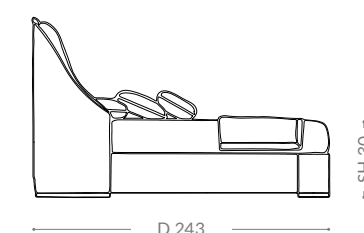
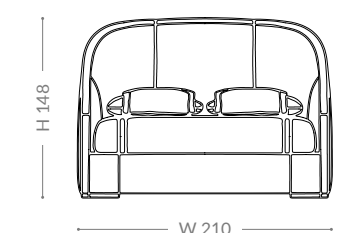

APOLLO Queen Size  
(Recommended mattress cm 180x200)

# BERNINI

BED



BEDS

Struttura in legno massello e multistrati di legno. Testata decorata con lavorazione *capitoné* e fasce trapuntate. Base in legno di faggio laccata. Imbottiture in poliuretano a quote differenziate. Rete a doghe in legno compresa. Dimensioni previste: queen e king size. Set letto disponibile su richiesta.

Solid wood and plywood structure. Bed header quilted with *capitoné* and vertical bands decorations. Beechwood lacquered base. Multiple densities polyurethane foam padding. Wooden slat included. Available in queen and king size. Bed set available on request.

Каркас из массива дерева и фанеры. Изголовье кровати со стеганой отделкой в виде каретной стяжки и вертикальными полосами. Основа из лакированной древесины бука. Набивка из пенополиуретана разной плотности. С деревянными ламелями. Доступные размеры: Queen size и King size. Постельное белье можно приобрести по запросу.

实木和胶合板结构。加衬垫绗缝软包床头,点缀竖直带形装饰。山毛榉漆木床底板。多重密度聚氨酯泡沫填充垫料。含实木板条。可选大号 and 超大号。可根据请求提供床套。

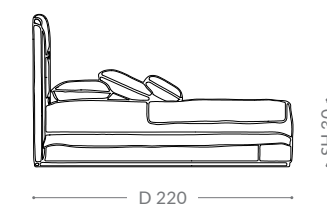
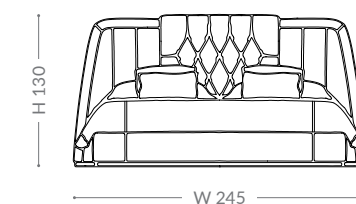

BERNINI King Size  
(Recommended mattress cm 200x200)

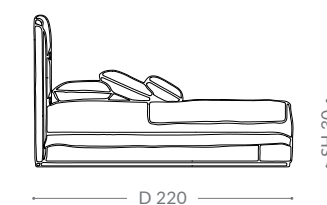
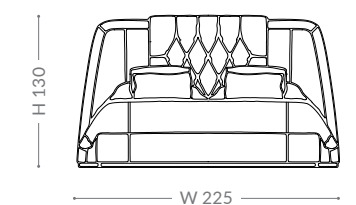

BERNINI Queen Size  
(Recommended mattress cm 180x200)

As picture: Bernini bed  
In price list: Ambition

Lucidatura/Finishing/Отделка/饰面  
80. IVORY MATT  
Letto e sommier/Bed and sommier/  
Кровать и каркас кровати/床和床垫  
BZ 905-5072 LEATHER CHAMPAGNE

Trapunta/Quilt/Стеганое одеяло/被子  
BZ 126-52 UNITO IVORY  
Plaid/Plaid/Плед/格纹  
BZ 184-901 PALMA BEIGE/IVORY

Cuscini/Pillows/Подушки/抱枕  
BZ 126-52 UNITO IVORY  
BZ 193-10 VELVET BEIGE  
BZ 195-071 WAVE BEIGE

# BERNINI WIDE

BED

Struttura in legno massello e multistrati di legno. Testata in versione allargata per contenere i comodini, decorata con lavorazione *capitoné* e fasce trapuntate. Base in legno di faggio laccata. Imbottiture in poliuretano a quote differenziate. Rete a doghe in legno compresa. Dimensioni previste: king size. Set letto disponibile su richiesta.

Solid wood and plywood structure. Enlarged bed header to fit bedside tables; quilted with *capitoné* and vertical bands decorations. Beechwood lacquered base. Multiple densities polyurethane foam padding. Wooden slat included. Available in king size. Bed set available on request.

Каркас из массива дерева и фанеры. Увеличенное изголовье кровати позволяет устанавливать прикроватные тумбочки. Стеганая отделка в виде каретной стяжки и вертикальные полосы. Основа из лакированной древесины бука. Набивка из пенополиуретана разной плотности. С деревянными ламелями. Доступный размер: King size. Постельное белье можно приобрести по запросу.

实木和胶合板结构。放大床头板以便适合床边桌。床头板采用超大软垫绗缝，点缀垂直带形装饰。漆木山毛榉床底板。多重密度聚氨酯泡沫填充垫料。含实木板条。超大床尺寸。可根据请求提供床套。



B E D S

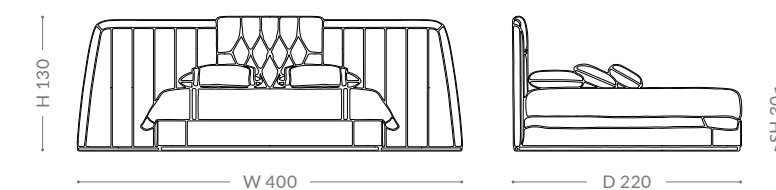

BERNINI WIDE King Size  
(Recommended mattress cm 200x200)

As picture: Bernini Wide bed  
In price list: Supreme

Lucidatura/Finishing/Отделка/饰面  
86. BLACK MATT  
Trapunta/Quilt/Стеганое одеяло/被子  
BZ 212-0485 SATIN LIGHT GREY

Letto e sommier/Bed and sommier/  
Кровать и каркас кровати/床和床垫  
BZ 905-5141 LEATHER DARK GREY  
BZ 902-N8401 NABUK DARK GREY

Cuscini/Pillows/Подушки/抱枕  
BZ 212-0485 SATIN LIGHT GREY  
BZ 192-003 CHEVRON GREY  
BZ 202-37 VELVET LIGHT GREY

# BERNINI XYLO

BED



Struttura in legno massello e multistrati di legno. Testata decorata con lavorazione capitonné e fasce trapuntate. Cornice testata e base in noce canaletto. Imbottiture in poliuretano a quote differenziate. Rete a doghe in legno compresa. Dimensioni previste: queen e king size. Set letto disponibile su richiesta.

Solid wood and plywood structure. Bed header quilted with capitonné and vertical bands decorations. Canaletto walnut wooden header profile and base. Multiple densities polyurethane foam padding. Wooden slat included. Available in queen and king size. Bed set available on request.

Каркас из массива дерева и фанеры. Изголовье кровати со стеганой отделкой в виде каретной стяжки и вертикальными полосами. Основа и профиль изголовья выполнены из ореха каналетто. Набивка из пенополиуретана разной плотности. С деревянными ламелями. Доступные размеры: Queen size и King size. Постельное белье можно приобрести по запросу.

实木和胶合板结构。加衬垫绗缝软包床头,点缀竖直带形装饰。卡纳莱托胡桃木床头轮廓线和底板。多重密度聚氨酯泡沫填充垫料。含实木板条。可选大号 and 超大号。可根据请求提供床套。



B E D S

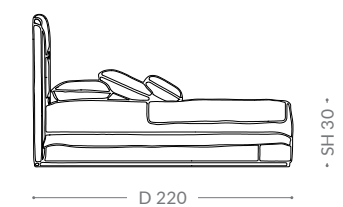
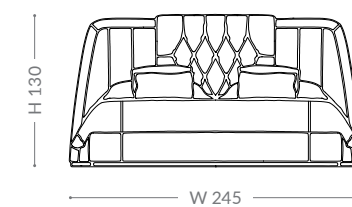

BERNINI XYLO King Size  
(Recommended mattress cm 200x200)

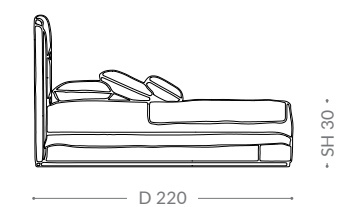
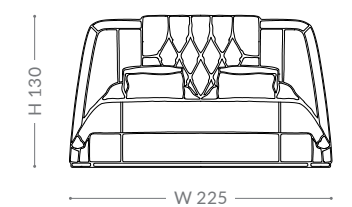

BERNINI XYLO Queen Size  
(Recommended mattress cm 180x200)

As picture: Bernini Xylo bed  
In price list: Prestige

Lucidatura/Finishing/Отделка/饰面  
70. CANALETTO WALNUT MATT  
Letto e sommier/Bed and sommier/  
Кровать и каркас кровати/床和床垫  
BZ 211-0814 VELVET MELANGE BEIGE

Trapunta/Quilt/Стеганое одеяло/被子  
BZ 212-1078 SATIN MASTIC  
Plaid/Plaid/Плед/格纹  
BZ 212-1497 SATIN CAMEL

Cuscini/Pillows/Подушки/抱枕  
BZ 212-1078 SATIN MASTIC  
BZ 214-01 VELVET CARVED CAMEL  
BZ 211-0814 VELVET MELANGE BEIGE



# BERNINI XYLO WIDE

BED



B E D S

As picture: Bernini Xylo  
Wide bed

In price list: Ambition/Brilliant

Lucidatura/Finishing/Отделка/饰面  
69. CANALETTO WALNUT

Letto e sommier/Bed and sommier/  
Кровать и каркас кровати/床和床垫  
BZ 901-632 LEATHER LIGHT BROWN

Trapunta/Quilt/Стеганое одеяло/被子  
BZ 126-50 UNITO SAND/PEARL

Cuscini/Pillows/Подушки/抱枕  
BZ 126-50 UNITO SAND/PEARL  
BZ 217-106 VELVET IVORY  
BZ 183-901 RAILING WHITE/GOLD

Struttura in legno massello e multistrati di legno. Testata, in versione allargata per contenere i comodini, decorata con lavorazione *capitonné* e fasce trapuntate. Cornice testata e base in noce canaletto. Imbottiture in poliuretano a quote differenziate. Rete a doghe in legno compresa. Dimensioni previste: king size. Set letto disponibile su richiesta.

Solid wood and plywood structure. Enlarged bed header to fit bedside tables; quilted with *capitonné* and vertical bands decorations. Canaletto walnut wooden header profile and base. Multiple densities polyurethane foam padding. Wooden slat included. Available in king size. Bed set available on request.

Каркас из массива дерева и фанеры. Увеличенное изголовье кровати позволяет устанавливать прикроватные тумбочки. Стеганая отделка в виде каретной стяжки и вертикальные полосы. Основа и профиль изголовья выполнены из ореха каналетто. Набивка из пенополиуретана разной плотности. С деревянными ламелями. Доступный размер: King size. Постельное белье можно приобрести по запросу.

实木和胶合板结构。放大床头板以便适合床边桌。床头板采用超大软垫绗缝，点缀垂直带形装饰。卡纳莱托胡桃木床头轮廓线和底板。多重密度聚氨酯泡沫填充垫料。含实木板条。超大床尺寸。可根据请求提供床套。

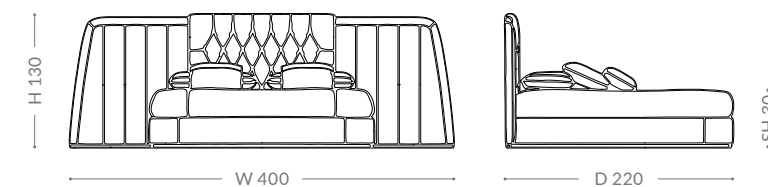

BERNINI XYLO WIDE King Size  
(Recommended mattress cm 200x200)

# CLEO

BED



Struttura in legno massello e multistrati di legno. Testata in versione allargata per contenere i comodini. Nicchie laterali disponibili in essenza di noce canaletto con luce a LED. Parte centrale composta da formelle imbottite in poliuretano a quote differenziate. Cornice perimetrale e giroletto realizzati in pelle. Rete a doghe in legno compressa. Dimensioni previste: queen e king size. Set letto disponibile su richiesta.

Solid wood and plywood structure. Enlarged bed header to fit bedside tables. Side recesses available in canaletto walnut veneer with LED lighting. Central panels padded in multiple densities polyurethane foam. Leather bed header profile and bed frame. Wooden slat included. Available in queen and king size. Bed set available on request.

Каркас из массива дерева и фанеры. Увеличенное изголовье кровати позволяет устанавливать прикроватные тумбочки. Боковые углубления из шпона ореха каналетто со светодиодной подсветкой. Набивка центральных панелей из пенополиуретана разной плотности. Каркас кровати и профиль изголовья обтянуты кожей. С деревянными ламелями. Доступные размеры: Queen size и King size. Постельное белье можно приобрести по запросу.

实木和胶合板结构。放大床头板以便适合床边桌。侧边的凹陷装饰为卡纳莱托胡桃木饰面板，配 LED 照明。中心床板内填充多种密度的聚氨酯泡沫垫料。皮革床头轮廓线条和床架。含实木板条。可选大号 and 超大号。可根据请求提供床套。

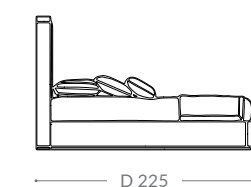
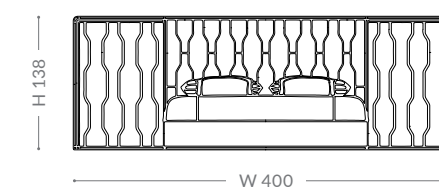

CLEO King Size  
(Recommended mattress cm 200x200)

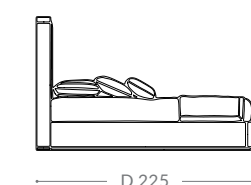
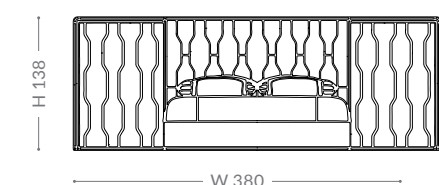

CLEO Queen Size  
(Recommended mattress cm 180x200)

B E D S

As picture: Cleo bed  
In price list: Exclusive/Brilliant

Lucidatura/Finishing/Отделка/饰面  
69. CANALETTO WALNUT - 54. GREY  
Letto e sommier/Bed and sommier/  
Кровать и каркас кровати/床和床垫  
BZ 203-009 BOUCLÉ BLUE  
BZ 901-702 LEATHER DOVE GREY

Трапунта/Quilt/Стеганое одеяло/被子  
BZ 212-1249 SATIN TAUPE  
Plaid/Plaid/Плед/格纹  
BZ 212-1078 SATIN MASTIC

Cuscini/Pillows/Подушки/抱枕  
BZ 212-1249 SATIN TAUPE  
BZ 212-1078 SATIN MASTIC  
BZ 203-009 BOUCLÉ BLUE

# HERMES

BED



B  
E  
D  
S

**As picture: Hermes bed**  
In price list: Prime/Brilliant

Lucidatura/Finishing/Отделка/饰面  
51. SAND - 66. PALISANDER  
Parti in metallo/Metal parts/Металлическая фурнитура/金属部件  
GOLD

Letto e sommier/Bed and sommier/  
Кровать и каркас кровати/床和床垫  
BZ 200-902 VELVET BEIGE  
Trapunta/Quilt/Стеганое одеяло/被子  
BZ 126-50 UNITO SAND/PEARL

Plaid/Plaid/Плед/格纹  
BZ 172-901 IVORY FANS  
Cuscini/Pillows/Подушки/抱枕  
BZ 126-50 UNITO SAND/PEARL  
BZ 171-901 MATELASSE IVORY  
BZ 200-902 VELVET BEIGE

Struttura in legno massello sagomato e multistrati di legno. Disponibile in essenza di legno palissandro. Testata e giroletto imbottiti in poliuretano a quote differenziate. Dettagli in ottone. Rete a doghe in legno compresa. Dimensioni previste: queen e king size. Set letto disponibile su richiesta.

Shaped solid wood and plywood structure. Available in palisander veneer. Bed header and bed frame padded in multiple densities polyurethane foam. Brass details. Wooden slat included. Available in queen and king size. Bed set available on request.

Фигурный каркас из массива дерева и фанеры. Материал: шпон палисандра. Навивка изголовья и каркаса кровати из пенополиуретана разной плотности. Латунные детали. С деревянными ламелями. Доступные размеры: Queen size и King size. Постельное белье можно приобрести по запросу.

实木型材和胶合板结构。花梨木饰面板。床头和床架内填充多种密度的聚氨酯泡沫垫料。黄铜细节装饰。含实木板条。可选大号 and 超大号。可根据请求提供床套。

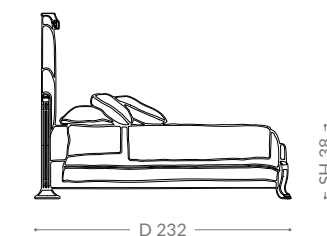
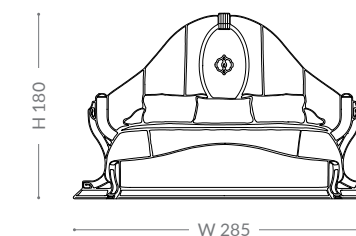

HERMES King Size  
(Recommended mattress cm 200x200)

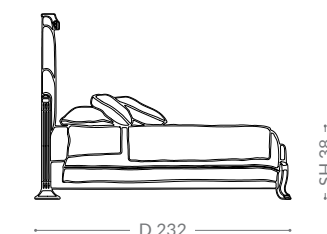
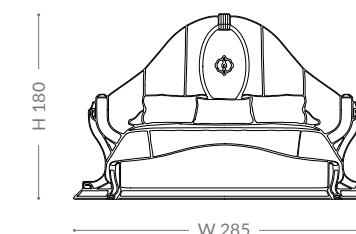

HERMES Queen Size  
(Recommended mattress cm 180x200)

# HERMITAGE

BED



Struttura in legno massello e multistrati di legno. Testata decorata con lavorazione *capitoné*. Applicazione laterale in legno laccato con inserto in specchio bronzo. Imbottiture in poliuretano a quote differenziate. Rete a doghe in legno compresa. Dimensioni previste: queen e king size. Set letto disponibile su richiesta.

Solid wood and plywood structure. *Capitoné* bed header. Side insert in lacquered wood, with bronze mirror inlay. Multiple densities polyurethane foam padding. Wooden slat included. Available in queen and king size. Bed set available on request.

Каркас из массива дерева и фанеры. Изголовье с отделкой в виде каретной стяжки. Боковые вставки из лакированной древесины с зеркальными элементами бронзового оттенка. Набивка из пенополиуретана разной плотности. С деревянными ламелями. Доступные размеры: Queen size и King size. Постельное белье можно приобрести по запросу.

实木和胶合板结构。加衬垫床头。侧面点缀漆木镶板，内嵌镜面黄铜。多重密度聚氨酯泡沫填充垫料。含实木板条。可选大号 and 超大号。可根据请求提供床套。

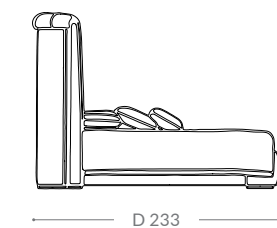
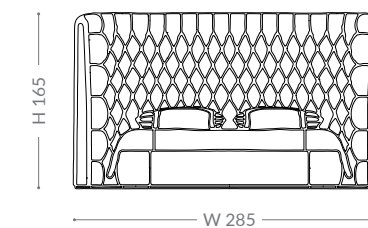

HERMITAGE King Size  
(Recommended mattress cm 200x200)

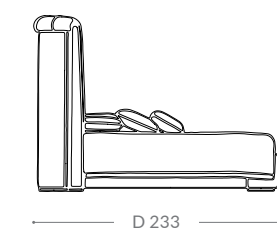
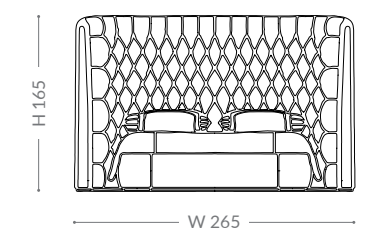

HERMITAGE Queen Size  
(Recommended mattress cm 180x200)

B E D S

As picture: Hermitage bed  
In price list: Prestige

Lucidatura/Finishing/Отделка/饰面  
85. CHOCOLATE MATT  
Parti in metallo/Metal parts/Металлическая фурнитура/金属部件  
GOLD

Letto e sommier/Bed and sommier/  
Кровать и каркас кровати/床和床垫  
BZ 216-120 VELVET RHUBARB  
Trapunta/Quilt/Стеганое одеяло/被子  
BZ 212-1078 SATIN MASTIC

Cuscini/Pillows/Подушки/抱枕  
BZ 212-1078 SATIN MASTIC  
BZ 203-008 BOUCLÉ PLUM  
BZ 216-120 VELVET RHUBARB

# HORIZON

BED



Struttura in legno massello e multistrati di legno curvato. Testata decorata con ricamo. Piedini e profili in metallo satinato. Imbottiture in poliuretano a quote differenziate. Rete a doghe in legno compresa. Dimensioni previste: queen e king size. Set letto disponibile su richiesta.

Solid wood and curved plywood structure. Quilted bed header. Satin metal feet and base. Multiple densities polyurethane foam padding. Wooden slat included. Available in queen and king size. Bed set available on request.

Каркас из массива дерева и изогнутой фанеры. Стеганое изголовье. Ножки и основа из сатинированного металла. Набивка из пенополиуретана разной плотности. С деревянными ламелями. Доступные размеры: Queen size и King size. Постельное белье можно приобрести по запросу.

实木和曲面胶合板结构。绗缝床头。缎纹金属脚和把手。多重密度聚氨酯泡沫填充垫料。含实木板条。可选大号 and 超大号。可根据请求提供床套。



B E D S

**As picture: Horizon bed**  
In price list: Supreme/Brilliant

Lucidatura/Finishing/Отделка/饰面  
57. CHOCOLATE  
85. CHOCOLATE MATT  
Parti in metallo/Metal parts/Металлическая фурнитура/金属部件  
SATIN GOLD

Letto e sommier/Bed and sommier/  
Кровать и каркас кровати/床和床垫  
BZ 902-N8405 NABUK DOVE GREY  
Trapunta/Quilt/Стеганое одеяло/被子  
BZ 212-1078 SATIN MASTIC

Cuscini/Pillows/Подушки/抱枕  
BZ 212-1078 SATIN MASTIC  
BZ 198-05 BOUCLÉ TWINE

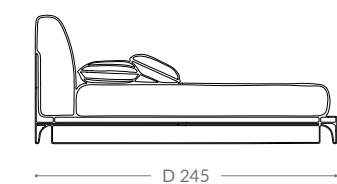
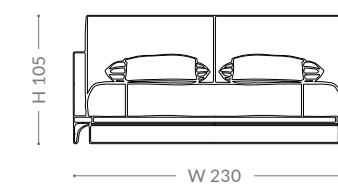

HORIZON King Size  
(Recommended mattress cm 200x200)

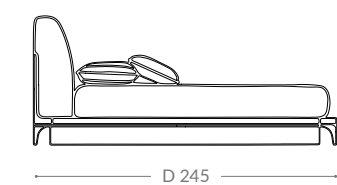
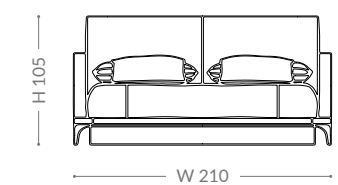

HORIZON Queen Size  
(Recommended mattress cm 180x200)

# JUNO

BED



Struttura in legno massello e multistrati di legno. Disponibile in essenza di ebano makassar. Pannello centrale decorato con lavorazione capitonné. Colonne decorative in legno con elementi verticali in ottone. Profili e dettagli in metallo. Imbottiture in poliuretano a quote differenziate. Rete a doghe in legno compresa. Dimensioni previste: queen e king size. Set letto disponibile su richiesta.

Solid wood and plywood structure. Available in makassar ebony veneer. *Capitonné* bed header central panel. Wooden decorative column, with brass decorations. Metal profiles and details. Multiple densities polyurethane foam padding. Wooden slat included. Available in queen and king size. Bed set available on request.

Каркас из массива дерева и фанеры. Материал: шпон макаassarского эбена. Центральная панель изголовья кровати с отделкой в виде каретной стяжки. Деревянные декоративные ножки-колонны с латунной отделкой. Металлические профили и детали. Навивка из пенополиуретана разной плотности. С деревянными ламелями. Доступные размеры: Queen size и King size. Постельное белье можно приобрести по запросу.

实木和胶合板结构。孟加锡乌木饰面板。床头中心床板点缀软垫绗缝木制装饰立柱，点缀黄铜装饰。金属轮廓线条及细节装饰。多重密度聚氨酯泡沫填充垫料。含实木板条。可选大号 and 超大号。可根据请求提供床套。

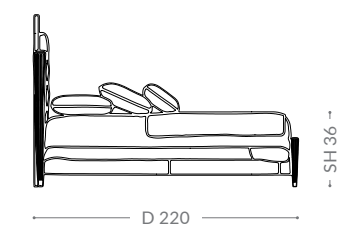
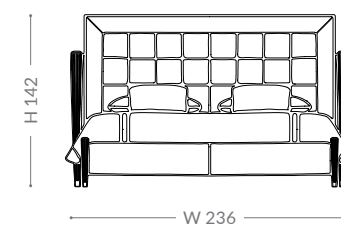

JUNO King Size  
(Recommended mattress cm 200x200)

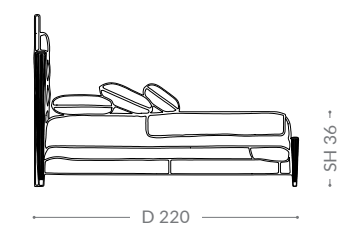
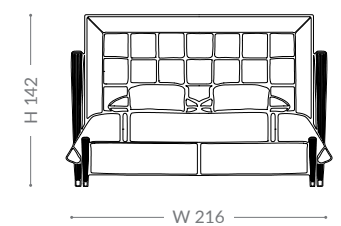

JUNO Queen Size  
(Recommended mattress cm 180x200)

B E D S

As picture: Juno bed  
In price list: Ambition/Brilliant

Lucidatura/Finishing/Отделка/饰面  
65. MAKASSAR  
57. CHOCOLATE  
Parti in metallo/Metal parts/Металлическая фурнитура/金属部件  
GOLD

Letto e sommier/Bed and sommier/  
Кровать и каркас кровати/床和床垫  
BZ 901-891 LEATHER IVORY  
Trapunta/Quilt/Стеганое одеяло/被子  
BZ 126-52 UNITO IVORY

Plaid/Plaid/Плед/格纹  
BZ 194-070 STRIPE BEIGE  
Cuscini/Pillows/Подушки/抱枕  
BZ 126-52 UNITO IVORY  
BZ 193-10 VELVET BEIGE  
BZ 194-070 STRIPE BEIGE

# KING

BED



**As picture: King bed**  
In price list: Prestige

Parti in metallo/Metal parts/Металлическая фурнитура/金属部件  
TITANIUM

Letto e sommier/Bed and sommier/Кровать и каркас кровати/床和床垫  
BZ 118-094 VELVET GREY

Trapunta/Quilt/Стеганое одеяло/被子  
BZ 126-51 UNITO GREY/PEARL  
Cuscini/Pillows/Подушки/抱枕  
BZ 126-51 UNITO GREY/PEARL  
BZ 118-094 VELVET GREY

Struttura in legno massello e multistrati di legno. Testata decorata con lavorazione a trapunta. Piedini in fusione di ottone. Imbottiture in poliuretano a quote differenziate. Rete a doghe in legno compresa. Dimensioni previste: standard, queen e king size. Set letto disponibile su richiesta.

Solid wood and plywood structure. Quilted bed header. Cast brass feet. Multiple densities polyurethane foam padding. Wooden slat included. Available in standard, queen and king size. Bed set available on request.

Каркас из массива дерева и фанеры. Стеганое изголовье. Ножки из литейной латуни. Набивка из пенополиуретана разной плотности. С деревянными ламелями. Доступные размеры: стандартный, Queen size и King size. Постельное белье можно приобрести по запросу.

实木和胶合板结构。绗缝床头。铸黄铜床脚。多重密度聚氨酯泡沫填充垫料。含实木板条。可选标准、大号 and 超大号。可根据请求提供床套。

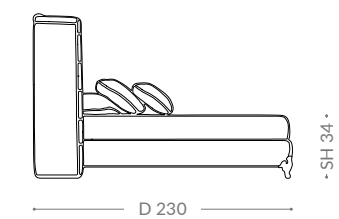
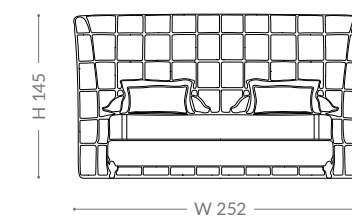

**KING King Size**  
(Recommended mattress cm 200x200)

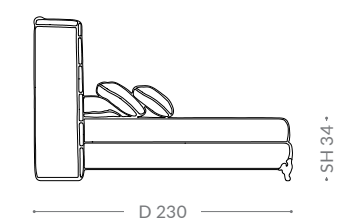
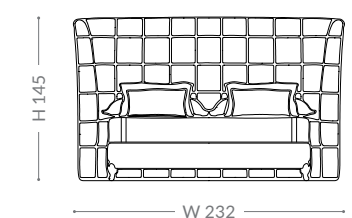

**KING Queen Size**  
(Recommended mattress cm 180x200)

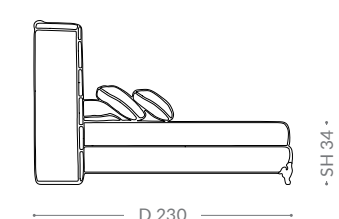
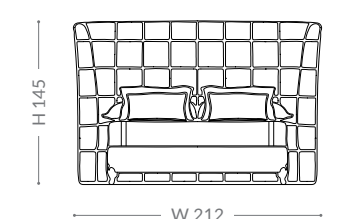

**KING Standard Size**  
(Recommended mattress cm 160x200)

# MADISON

BED



Struttura in legno massello; basamento in legno decorato. Selle copritestata in pelle ricamata con fibbia in ottone. Imbottiture in poliuretano espanso a quote differenziate. Rete a doghe in legno compressa. Dimensioni previste: standard, queen e king size. Set letto disponibile su richiesta.

Solid wood structure; wooden decorated base. Leather bed header covers, with brass buckle. Multiple densities polyurethane foam padding. Wooden slat included. Available in standard, queen and king size. Bed set available on request.

Каркас из массива дерева, деревянная основа с отделкой. Кожаные чехлы для изголовья кровати с застежкой из латуни. Набивка из пенополиуретана разной плотности. С деревянными ламелями. Доступные размеры: стандартный, Queen size и King size. Постельное белье можно приобрести по запросу.

实木结构，木饰床架。黄铜口装饰包皮床头多重密度聚氨酯泡沫填充垫料。含实木板条。可选标准、大号和超大号。可根据请求提供床套。

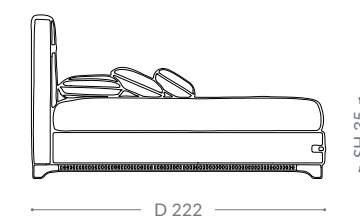
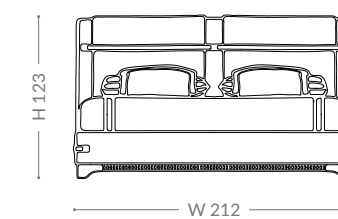

MADISON King Size  
(Recommended mattress cm 200x200)

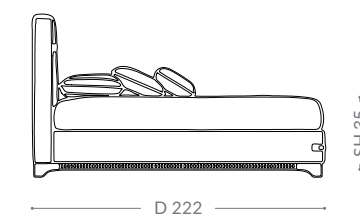
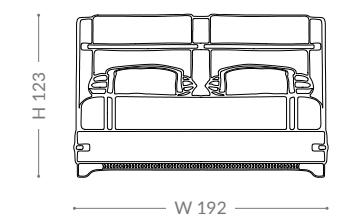

MADISON Queen Size  
(Recommended mattress cm 180x200)

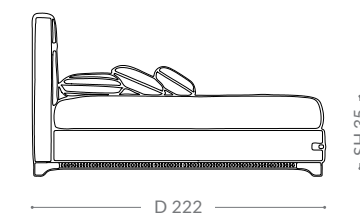
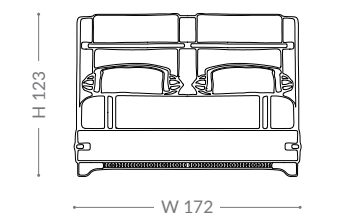

MADISON Standard Size  
(Recommended mattress cm 160x200)

B E D S

As picture: Madison bed  
In price list: Prestige/Brilliant

Lucidatura/Finishing/Отделка/饰面  
54. GREY  
Parti in metallo/Metal parts/Металлическая фурнитура/金属部件  
DIAMOND TITANIUM

Letto e sommier/Bed and sommier/  
Кровать и каркас кровати/床和床垫  
BZ 216-222 VELVET LIGHT GREY  
BZ 906-2006 LEATHER TAUPE  
Трапунта/Quilt/Стеганое одеяло/被子  
BZ 126-51 UNITO GREY/PEARL

Cuscini/Pillows/Подушки/抱枕  
BZ 126-51 UNITO GREY/PEARL  
BZ 214-03 VELVET CARVED BLUE  
BZ 216-222 VELVET LIGHT GREY



# OCEAN

BED



B E D S

**As picture: Ocean bed**  
In price list: Ambition/Brilliant

Lucidatura/Finishing/Отделка/饰面  
69. CANALETTO WALNUT  
94. TAUPE  
Parti in metallo/Metal parts/Металлическая фурнитура/金属部件  
SATIN GOLD

Letto e sommier/Bed and sommier/  
Кровать и каркас кровати/床和床垫  
BZ 906-2007 LEATHER MOKA  
Trapunta/Quilt/Стеганое одеяло/被子  
BZ 212-1078 SATIN MASTIC

Plaid/Plaid/Плед/格纹  
BZ 213-03 SHANTUNG PUTTY  
Cuscini/Pillows/Подушки/抱枕  
BZ 212-1078 SATIN MASTIC  
BZ 212-2836 SATIN MALVA  
BZ 210-02 PLUM FLOWER

Struttura in legno massello e multistrati di legno. Testata decorata con lavorazione capitonné. Cornice testata in noce canaletto con applicazione in metallo satinato. Imbottiture in poliuretano a quote differenziate. Rete a doghe in legno compresa. Dimensioni previste: queen e king size. Set letto disponibile su richiesta.

Solid wood and plywood structure. Capitonné bed header. Canaletto walnut wooden bed header profile, with metal satin decoration. Multiple densities polyurethane foam padding. Wooden slat included. Available in queen and king size. Bed set available on request.

Каркас из массива дерева и фанеры. Изголовье с отделкой в виде каретной стяжки. Профиль изголовья выполнен из древесины ореха каналетто и украшен сатинованным металлом. Набивка из пенополиуретана разной плотности. С деревянными ламелями. Доступные размеры: Queen size и King size. Постельное белье можно приобрести по запросу.

实木和胶合板结构。加衬垫床头。卡纳莱托胡桃木床头轮廓线，点缀缎纹金属装饰。多重密度聚氨酯泡沫填充垫料。含实木板条。可选大号 and 超大号。可根据请求提供床套。

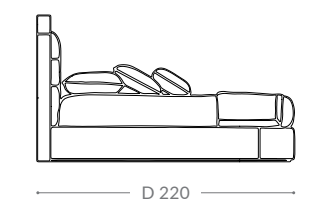
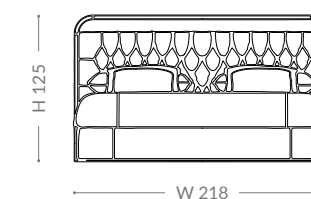

OCEAN King Size  
(Recommended mattress cm 200x200)

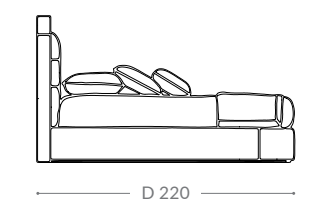
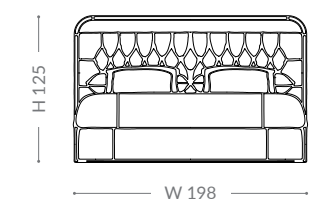

OCEAN Queen Size  
(Recommended mattress cm 180x200)

# OVERWALL

BED



B E D S

**As picture: Overwall bed**  
In price list: Ambition/Brilliant/  
Led lighting on request

Lucidatura/Finishing/Отделка/饰面  
69. CANALETTO WALNUT  
57. CHOCOLATE

Letto e sommier/Bed and sommier/  
Кровать и каркас кровати/床和床垫  
BZ 906-2005 LEATHER OASI  
Trapunta/Quilt/Стеганое одеяло/被子  
BZ 212-1078 SATIN MASTIC

Cuscini/Pillows/Подушки/抱枕  
BZ 213-03 SHANTUNG PUTTY  
BZ 218-206 VELVET CARVED BROWN

Struttura in legno massello e multistrati di legno. Cornice testata in noce canaletto con luce a LED disponibile su richiesta. Parte interna decorata in pelle ricamata. Imbottiture in poliuretano a quote differenziate. Rete a doghe in legno compresa. Dimensioni previste: queen e king size. Set letto disponibile su richiesta.

Solid wood and plywood structure. Canaletto wooden bed header frame, with LED lighting on request; inner part with quilted leather decoration. Multiple densities polyurethane foam padding. Wooden slat included. Available in queen and king size. Bed set available on request.

Каркас из массива дерева и фанеры. Рама изголовья кровати из древесины ореха каналетто, со светодиодной подсветкой можно приобрести по запросу. Внутри украшена стеганой кожей. Набивка из пенополиуретана разной плотности. С деревянными ламелями. Доступные размеры: Queen size и King size. Постельное белье можно приобрести по запросу.

实木和胶合板结构。卡纳莱托实木床头板，可应求提供LED照明。内侧部分饰以绗缝皮革。多重密度聚氨酯泡沫填充垫料。含实木板条。可选大号 and 超大号。可根据请求提供床套。

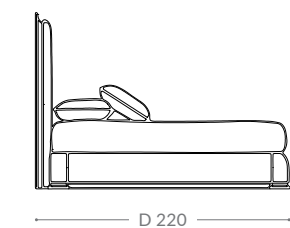
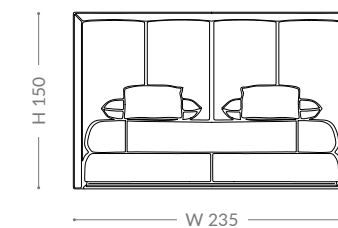

OVERWALL King Size  
(Recommended mattress cm 200x200)

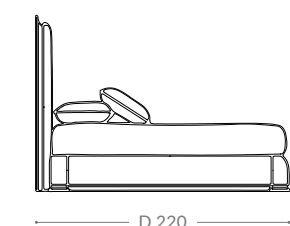
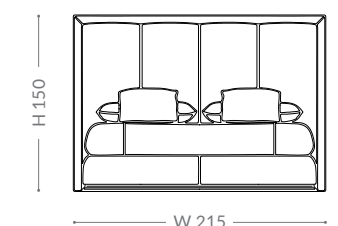

OVERWALL Queen Size  
(Recommended mattress cm 180x200)



ZB

## BEDSIDE TABLES



# BUSTER

BEDSIDE TABLE



BEDSIDE TABLES

**As picture: Buster bedside table**  
In price list: Brilliant



Lucidatura/Finishing/Отделка/饰面  
51. SAND  
64. CANALETTO WALNUT

Parti in metallo/Metal parts/Металлическая фурнитура/金属部件  
GOLD

Struttura in legno massello e multistrati di legno. Piedini in legno intagliati a mano. Piano disponibile in essenza di noce canaletto, ebano makassar o marmo. Maniglie in ottone.

Solid wood and plywood structure. Hand-carved wooden feet. Top available in canaletto walnut veneer, makassar ebony veneer or marble. Brass handles.

Каркас из массива дерева и фанеры. Деревянные ножки ручной работы. Доступные материалы столешницы: шпон ореха каналетто или макассарского эбена, мрамор. Латунные ручки.

实木和胶合板结构。手工雕刻木脚。台面可选用卡纳莱托胡桃木饰面板、孟加锡乌木饰面板或大理石。黄铜把手。

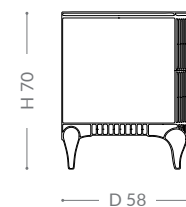
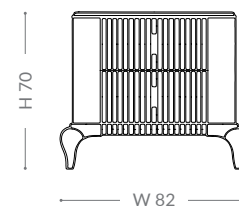

# CLARK

BEDSIDE TABLE



**As picture: Clark bedside table**  
In price list: Brilliant

Lucidatura/Finishing/Отделка/饰面  
54. GREY

Struttura in legno massello, multistrati di legno e MDF. Cassetti con decorazione in bassorilievo. Disponibile in legno laccato.

Solid wood, plywood and MDF structure. Drawers with low relief decoration. Available in lacquered wood.



BEDSIDE TABLES

Каркас из массива дерева, фанеры и МДФ. Ящики украшены барельефом. Материал: лакированная древесина.

实木、胶合板和中密度纤维板结构。抽屉点缀浅浮雕装饰。漆木质地。

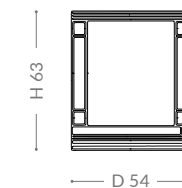
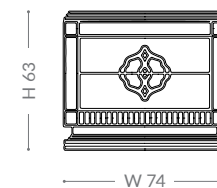

# ELYPSE

BEDSIDE TABLE



BEDSIDE TABLES

**As picture: Elypse bedside table**  
In price list: Prime

Lucidatura/Finishing/Отделка/饰面  
100. GREY MATT

Parti in metallo/Metal parts/Металлическая фурнитура/金属部件  
TITANIUM

Materiale/Material/Материал/材料  
BZ 906-2005 LEATHER OASI

Struttura in multistrati di legno curvato e legno massello. Parte esterna decorata in pelle ricamata. Parte interna rivestita in pelle. Piano disponibile in legno laccato o marmo.

Curved plywood and solid wood structure. Quilted leather outer structure. Internal padded in leather. Top available in lacquered wood or marble.

Каркас из изогнутой фанеры и массива дерева. Наружная отделка стеганой кожей. Внутри обита кожей. Доступные материалы столешницы: лакированная древесина или мрамор.

曲面胶合板和实木结构外侧结构为衍缝皮革。内侧结构加皮革衬垫。桌面可选用漆木或大理石。

# ELYPSE

BEDSIDE TABLE



**As picture: Elypse bedside table**  
In price list: Brilliant/Precious stone

Lucidatura/Finishing/Отделка/饰面  
57. CHOCOLATE  
Marmo/Marble/Мрамор/大理石  
EMPERADOR DARK

Parti in metallo/Metal parts/Металлическая фурнитура/金属部件  
GOLD

Materiale/Material/Материал/材料  
BZ 906-2003 LEATHER  
DARK BROWN

BEDSIDE TABLES

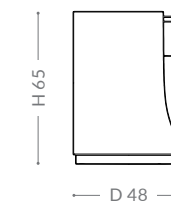
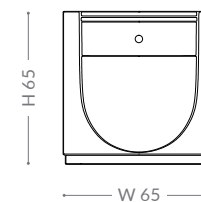

# GLENN

BEDSIDE TABLE

BEDSIDE TABLES

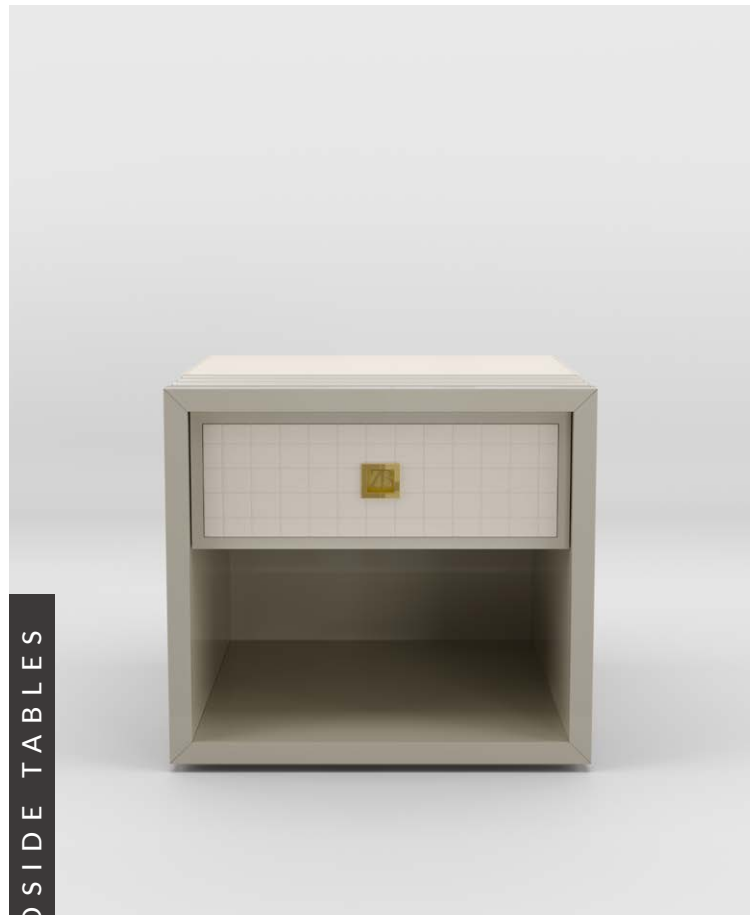

**As picture: Glenn bedside table**  
In price list: Brilliant

Lucidatura/Finishing/Отделка/饰面  
51. SAND

Parti in metallo/Metal parts/Металлическая фурнитура/金属部件  
GOLD

Materiale/Material/Материал/材料  
BZ 901-891 LEATHER IVORY

Struttura in legno massello e multistrati di legno. Piano e parte esterna rivestiti in pelle. Fronte cassetti decorati in pelle ricamata. Maniglie in ottone.

Solid wood and plywood structure. Top and outer structure padded in leather. Quilted leather front drawers. Brass handles.

Каркас из массива дерева и фанеры. Кожаная обивка сверху и снаружи. Фасады выдвижных ящиков отделаны стеганой кожей. Латунные ручки.

实木和胶合板结构。台面和外侧结构加皮革衬里。前部抽屉采用绗缝皮革。黄铜把手。

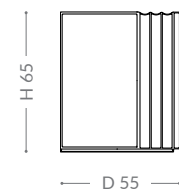
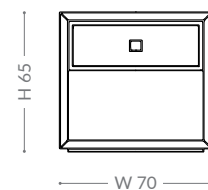

# HERMES

BEDSIDE TABLE



**As picture: Hermes bedside table**  
In price list: Brilliant

Lucidatura/Finishing/Отделка/饰面  
51. SAND  
66. PALISANDER

Parti in metallo/Metal parts/Металлическая фурнитура/金属部件  
GOLD

Materiale/Material/Материал/材料  
BZ 905-5234 LEATHER  
BEIGE

Struttura in legno massello, multistrati di legno curvato e MDF. Disponibile in essenza di palissandro. Fronte cassetto rivestito in pelle. Maniglia in metallo.

Solid wood, curved plywood and MDF structure. Available in palisander veneer. Front drawer padded in leather. Metal handle.

Каркас из массива дерева, изогнутой фанеры и МДФ. Материал: шпон палисандра. Фасад ящика обит кожей. Металлическая ручка.

实木、曲面胶合板和中密度纤维板结构。花梨木饰面板。前侧抽屉加皮革衬里。金属把手。

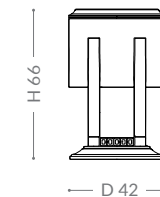
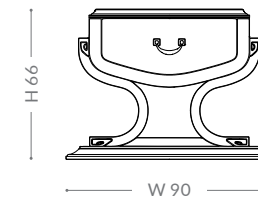

BEDSIDE TABLES

# HORIZON

BEDSIDE TABLE

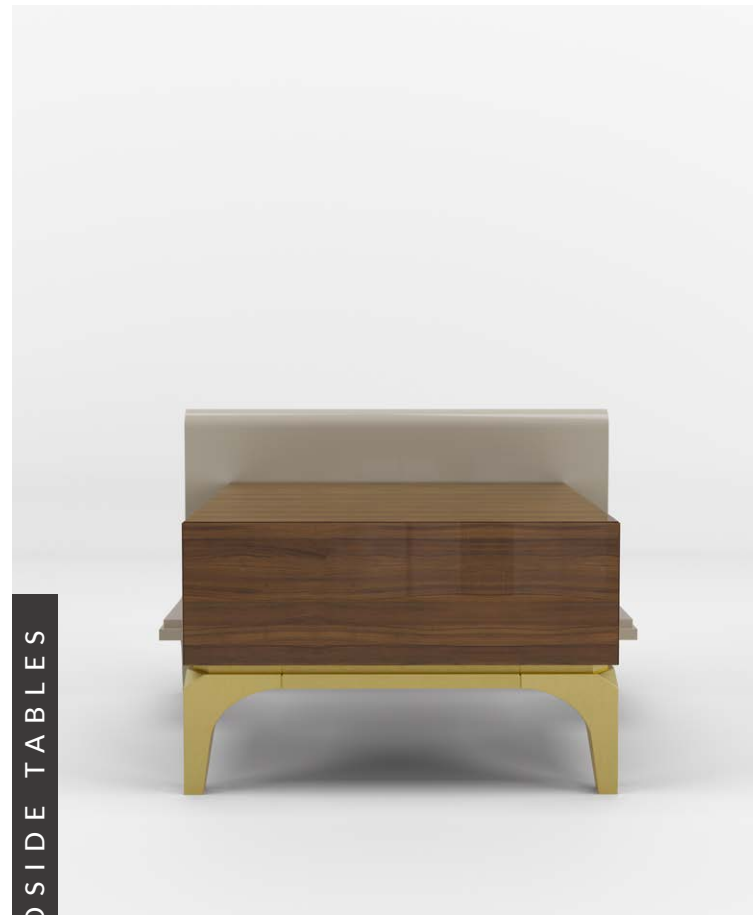

BEDSIDE TABLES

**As picture: Horizon bedside table**  
In price list: Brilliant



Lucidatura/Finishing/Отделка/饰面  
51. SAND  
69. CANALETTO WALNUT

Parti in metallo/Metal parts/Металлическая фурнитура/金属部件  
SATIN GOLD

Struttura in legno massello e multistrati di legno. Disponibile in essenza di noce canaletto. Piedini frontali e maniglia in metallo satinato.

Solid wood and plywood structure. Available in canaletto walnut veneer. Satin metal front feet and handle.

Каркас из массива дерева и фанеры. Материал: шпон ореха каналетто. Передние ножки и ручка из сатинированного металла.

实木和胶合板结构。卡纳莱托胡桃木饰面板。缎纹金属前柜脚和把手。

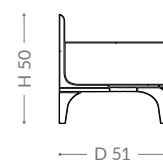
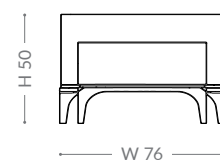

# OCEAN I

BEDSIDE TABLE



**As picture: Ocean I bedside table**  
In price list: Brilliant

Lucidatura/Finishing/Отделка/饰面  
94. TAUPE



Parti in metallo/Metal parts/Металлическая фурнитура/金属部件  
SATIN GOLD

Materiale/Material/Материал/材料  
BZ 906-2007 LEATHER MOKA

Struttura in metallo satinato e multistrati di legno curvato. Disponibile in legno laccato. Decorazione su cassetto frontale in pelle ricamata.

Satin metal and curved plywood structure. Available in lacquered wood. Front drawer padded in quilted leather.

Каркас из сатинированного металла и изогнутой фанеры. Материал: лакированная древесина. Фасад ящика обит стеганой кожей.

缎纹金属和曲面胶合板结构。漆木质地。前侧抽屉加绗缝皮革衬里。

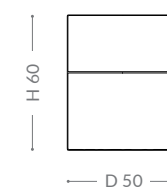
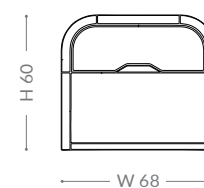

BEDSIDE TABLES

# OCEAN II

BEDSIDE TABLE

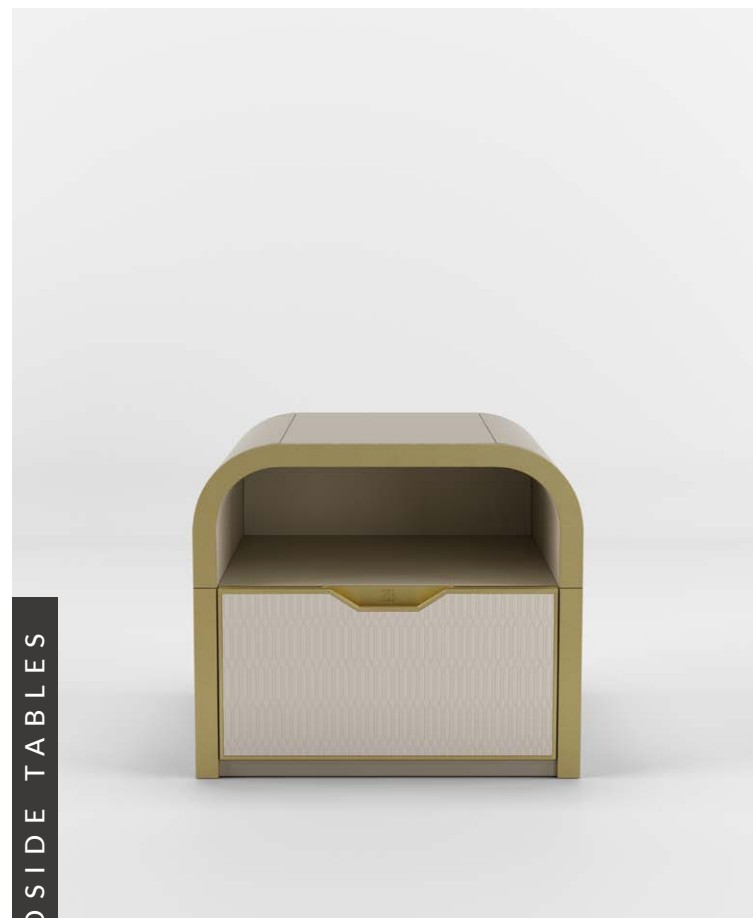

BEDSIDE TABLES

**As picture: Ocean II bedside table**  
In price list: Prime

Lucidatura/Finishing/Отделка/饰面  
81. SAND MATT



Parti in metallo/Metal parts/Металлическая фурнитура/金属部件  
SATIN GOLD

Materiale/Material/Материал/材料  
BZ 901-891 LEATHER IVORY

Struttura in metallo satinato e multistrati di legno curvato. Disponibile in legno laccato. Decorazione su cassetto frontale in pelle ricamata.

Satin metal and curved plywood structure. Available in lacquered wood. Front drawer padded in quilted leather.

Каркас из сатинированного металла и изогнутой фанеры. Материал: лакированная древесина. Фасад ящика обит стеганой кожей.

缎纹金属和曲面胶合板结构。漆木质地。前侧抽屉加绗缝皮革衬里。

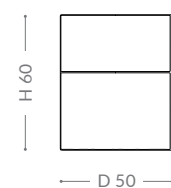
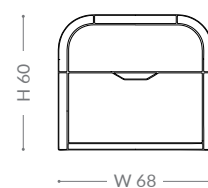

# REMINGTON

BEDSIDE TABLE



**As picture: Remington bedside table**  
In price list: Brilliant

Lucidatura/Finishing/Отделка/饰面  
57. CHOCOLATE

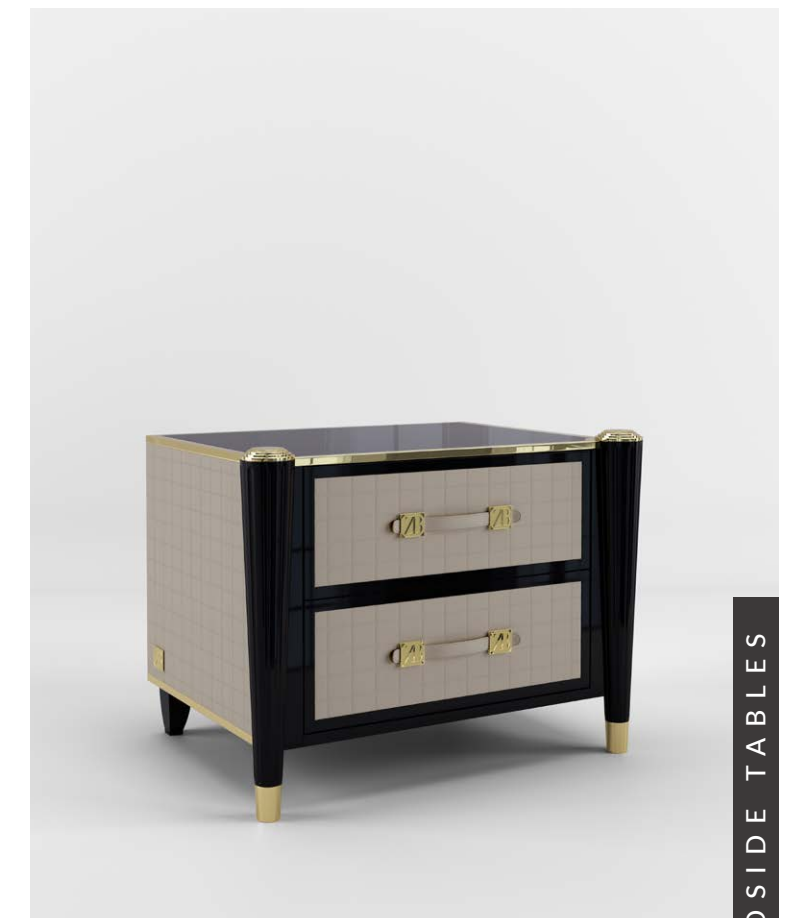

Parti in metallo/Metal parts/Металлическая фурнитура/金属部件  
GOLD

Materiale/Material/Материал/材料  
BZ 901-891 LEATHER IVORY

BEDSIDE TABLES

Struttura in legno massello, multistrati di legno e MDF. Piano in legno laccato. Parte laterale e cassette decorati in pelle ricamata. Dettagli e maniglie in ottone. Colonne decorative in legno con fresature verticali.

Solid wood, plywood and MDF structure. Lacquered wooden top. Quilted leather side parts and drawers. Brass handles and details. Wooden columns with fluted decorations.

Каркас из массива дерева, фанеры и МДФ. Столешница из лакированной древесины. Боковые части и выдвижные ящики из стеганой кожи. Латунные ручки и детали. Деревянные ножки-колонны с рифлеными украшениями.

实木、胶合板和中密度纤维板结构。漆木桌面。侧面部件和抽屉采用绗缝皮革。黄铜把手和配饰。五斗柜木制脚凹槽装饰。

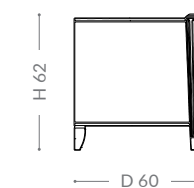
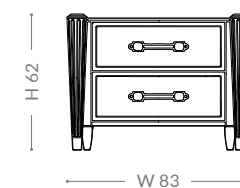



# STUART

BEDSIDE TABLE



BEDSIDE TABLES

**As picture: Stuart bedside table**  
In price list: Prime/  
Precious stone

Lucidatura/Finishing/Отделка/饰面  
81. SAND MATT  
Marmo/Marble/Мрамор/大理石  
CALACATTA CROMA-ARISTON



Parti in metallo/Metal parts/Метал-  
лическая фурнитура/金属部件  
SATIN GOLD

Materiale/Material/Материал/材料  
BZ 905-5072 LEATHER CHAMPAGNE

Struttura in multistrati di legno curvato e MDF. Piano disponibile in noce canaletto o marmo. Pannello laterale rivestito in pelle con inserto ricamato. Maniglie in metallo satinato.

Curved plywood and MDF structure. Top available in canaletto walnut veneer or marble. Side panel padded in leather with quilted decoration. Satin metal handles.

Каркас из изогнутой фанеры и МДФ. Доступные материалы столешницы: шпон ореха каналетто или мрамор. Боковые панели обиты кожей со стеганой отделкой. Ручки из сатинированного металла.

曲面胶合板和中密度纤维板结构。台面可选用卡纳莱托胡桃木饰面板或大理石。侧镶板加皮革衬里，点缀绗缝装饰。缎纹金属把手。

# STUART

BEDSIDE TABLE



**As picture: Stuart bedside table**  
In price list: Prime

Lucidatura/Finishing/Отделка/饰面  
70. CANALETTO WALNUT MATT  
89. TAUPE MATT

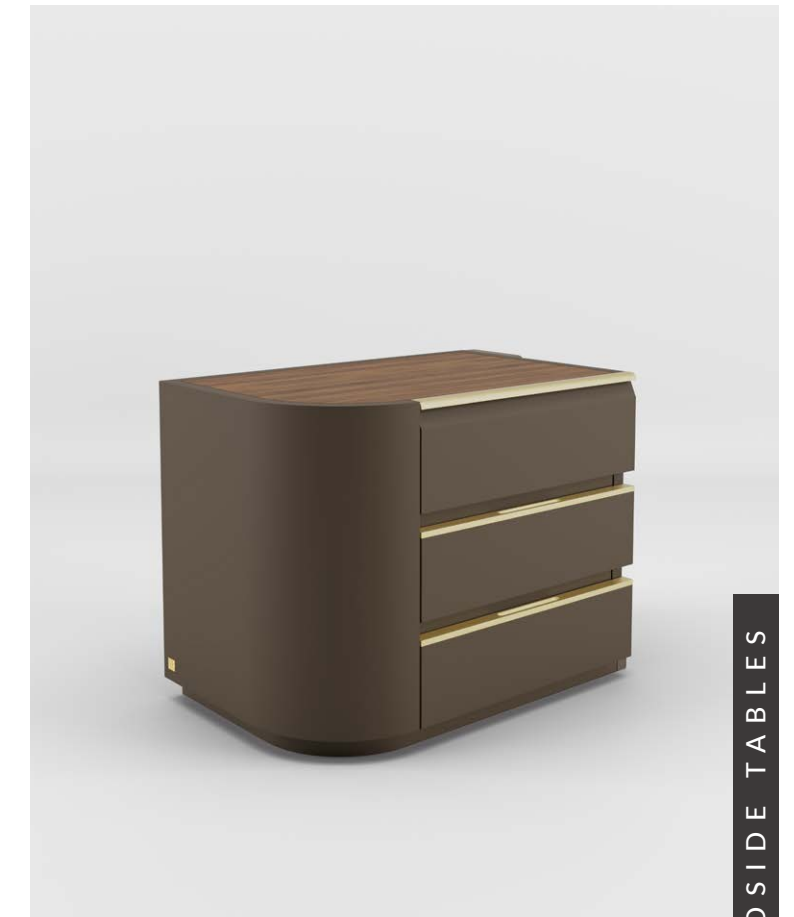

Parti in metallo/Metal parts/Метал-  
лическая фурнитура/金属部件  
SATIN GOLD

Materiale/Material/  
Материал/材料  
BZ 901-632 LEATHER LIGHT  
BROWN

BEDSIDE TABLES

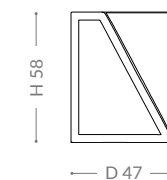
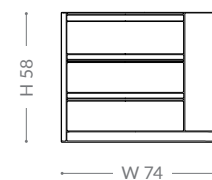



ZB

CHEST  
OF DRAWERS



# BUSTER

CHEST OF DRAWERS



CHEST OF DRAWERS

As picture: Buster chest of drawers  
In price list: Brilliant

Lucidatura/Finishing/Отделка/饰面  
57. CHOCOLATE  
65. MAKASSAR

Parti in metallo/Metal parts/Металлическая фурнитура/金属部件  
DIAMOND GOLD

Struttura in legno massello e multistrati di legno. Piedini in legno intagliati a mano. Piano disponibile in essenza di noce canaletto, ebano makassar o marmo. Maniglie in ottone.

Solid wood and plywood structure. Hand-carved wooden feet. Top available in canaletto walnut veneer, makassar ebony veneer or marble. Brass handles.

Каркас из массива дерева и фанеры. Деревянные ножки ручной работы. Доступные материалы столешницы: шпон ореха каналетто или макассарского эбена, мрамор. Латунные ручки.

实木和胶合板结构。手工雕刻木脚。台面可选用卡纳莱托胡桃木饰面板、孟加锡乌木饰面板或大理石。黄铜把手。



# BUSTER

CHEST OF DRAWERS

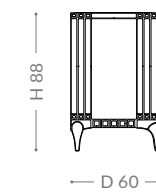
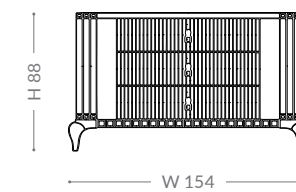

CHEST OF DRAWERS

**As picture: Buster chest of drawers**  
In price list: Brilliant

Lucidatura/Finishing/Отделка/饰面  
51. SAND  
63. WHITENED CANALETTO WALNUT

Parti in metallo/Metal parts/Металлическая фурнитура/金属部件  
DIAMOND GOLD

# DEANNA

CHEST OF DRAWERS



CHEST OF DRAWERS

Struttura in legno massello e multistrati di legno. Disponibile in essenza di noce canaletto. Piedini frontali e maniglie in metallo satinato.

Solid wood and plywood structure. Available in canaletto walnut veneer. Front feet and handles in satin metal.

Каркас из массива дерева и фанеры. Материал: шпон ореха каналетто. Передние ножки и ручки из сатинированного металла.

实木和胶合板结构。卡纳莱托胡桃木饰面板。前脚和把手为缎纹金属质地。

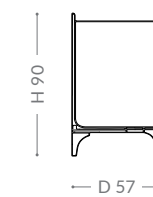
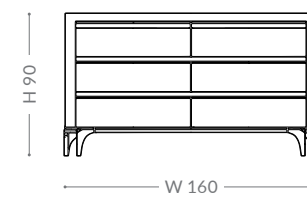

As picture: Deanna chest of drawers  
In price list: Brilliant

Lucidatura/Finishing/Отделка/饰面  
57. CHOCOLATE  
69. CANALETTO WALNUT

Parti in metallo/Metal parts/Металлическая фурнитура/金属部件  
SATIN GOLD

# GLENN

CHEST OF DRAWERS

Struttura in legno massello e multistrati di legno. Piano e parte esterna rivestiti in pelle. Fronte cassetti decorati in pelle ricamata. Maniglie in ottone.

Solid wood and plywood structure. Top and outer structure padded in leather. Quilted leather front drawers. Brass handles.

Каркас из массива дерева и фанеры. Кожаная обивка сверху и снаружи. Фасады выдвижных ящиков отделаны стеганой кожей. Латунные ручки.

实木和胶合板结构。台面和外侧结构加皮革衬里。前部抽屉采用绗缝皮革。黄铜把手。

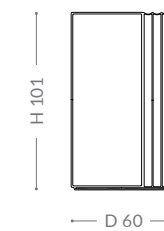
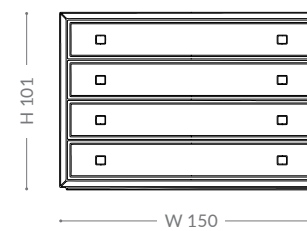

CHEST OF DRAWERS

As picture: Glenn chest of drawers  
In price list: Brilliant

Lucidatura/Finishing/Отделка/饰面  
51. SAND

Parti in metallo/Metal parts/Металлическая фурнитура/金属部件  
GOLD

Materiale/Material/Материал/材料  
BZ 901-891 LEATHER IVORY

# REMINGTON

CHEST OF DRAWERS



CHEST OF DRAWERS

As picture: Remington chest of drawers  
In price list: Brilliant

Lucidatura/Finishing/Отделка/饰面  
57. CHOCOLATE

Parti in metallo/Metal parts/Металлическая фурнитура/金属部件  
GOLD

Materiale/Material/Материал/材料  
BZ 901-891 LEATHER IVORY

Struttura in legno massello, multistrati di legno e MDF. Piano in legno laccato. Parte laterale e cassetti decorati in pelle ricamata. Dettagli e maniglie in ottone. Colonne decorative in legno con fresature verticali.

Solid wood, plywood and MDF structure. Lacquered wooden top. Quilted leather side parts and drawers. Brass handles and details. Wooden columns with fluted decorations.

Каркас из массива дерева, фанеры и МДФ. Столешница из лакированной древесины. Боковые части и выдвижные ящики из стеганой кожи. Латунные ручки и детали. Деревянные ножки-колонны с рифлеными украшениями.

实木、胶合板和中密度纤维板结构。漆木桌面。侧面部件和抽屉采用绗缝皮革。黄铜把手和配饰。五斗柜木制脚凹槽装饰。

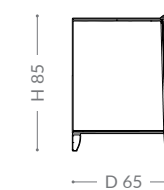
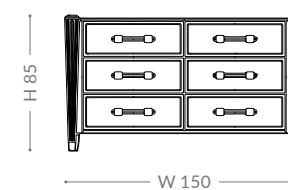



ZB

## DRESSING TABLES





# EMANUELLE

DRESSING TABLE



DRESSING TABLES

As picture: Emanuelle  
dressing table  
In price list: Brilliant

Lucidatura/Finishing/Отделка/饰面  
94. TAUPE

Parti in metallo/Metal parts/Метал-  
лическая фурнитура/金属部件  
SATIN GOLD

Materiale/Material/Материал/材料  
BZ 906-2007 LEATHER MOKA

Struttura in metallo satinato  
e multistrati di legno curvato.  
Disponibile con cassetti e ante  
in legno laccato. Decorazione  
su fianchi in pelle ricamata.  
Specchio molato su supporto  
metallico.

Satin metal and curved ply-  
wood structure. Available with  
lacquered wooden drawers  
and doors. Quilted leather  
side parts. Ground mirror on  
metallic support.

Каркас из сатинированного  
металла и изогнутой фане-  
ры. Дверцы и выдвижные  
ящики из лакированной  
древесины. Боковые поверх-  
ности отделаны стеганой ко-  
жей. Настольное зеркало на  
металлической подставке.

缎纹金属和曲面胶合板结构。  
漆木抽屉和门。侧面部件为绗  
缝皮革。金属支架上的卵形镜  
子。

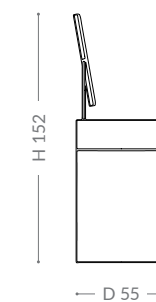
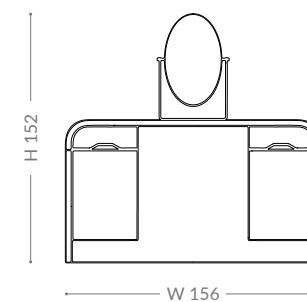

# KIMBERLY

DRESSING TABLE

Struttura in multistrati di legno curvato, rivestito in pelle. Gambe frontali in legno di faggio con dettagli metallici. Cassetto portagioie con anta decorata in pelle ricamata. Specchio molato.

Curved plywood structure, covered in leather. Beechwood legs with metal details. Jewelry drawer with quilted decoration. Ground mirror.

Каркас из изогнутой фанеры, обтянутый кожей. Ножки из древесины бука с металлическими деталями. Выдвижной ящик для украшений со стеганой отделкой. Настольное зеркало.

曲面胶合板结构，皮革包裹。山毛榉桌腿配有精细金属装饰。珠宝抽屉跟绗缝皮革。卵形镜子。



DRESSING TABLES

**As picture: Kimberly dressing table**  
In price list: Brilliant

Lucidatura/Finishing/Отделка/饰面  
50. IVORY

Parti in metallo/Metal parts/Металлическая фурнитура/金属部件  
GOLD

Materiale/Material/Материал/材料  
BZ 901-332 LEATHER BUTTER

**As picture: Kimberly pouf**  
In price list: Ambition

Pouf/Pouf/Пуф/沙发脚凳  
BZ 901-332 LEATHER BUTTER  
Lucidatura/Finishing/Отделка/饰面  
50. IVORY

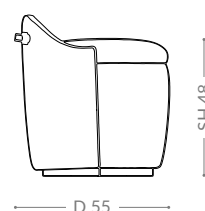
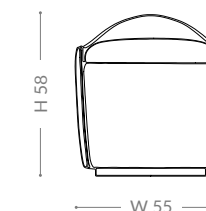
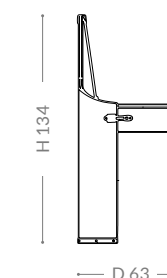
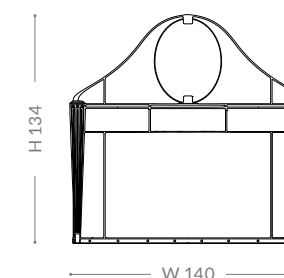

# MADemoISELLE

DRESSING TABLE

Struttura in legno massello e multistrati di legno. Disponibile in essenza di noce canaletto. Piedini frontali e maniglie in metallo martellato. Specchio molato su supporto metallico.

Solid wood and plywood structure. Available in canaletto walnut veneer. Hammered metal feet and handles. Ground mirror on metal support.

Каркас из массива дерева и фанеры. Материал: шпон ореха каналетто. Ножки и ручки из кованого металла. Настольное зеркало на подставке из металла.

实木和胶合板结构。卡纳莱托核桃木饰面板，金色锻造金属柜脚和把手。金属支架上的镜子。



DRESSING TABLES

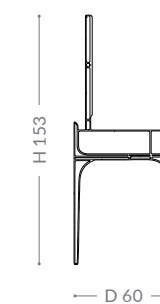
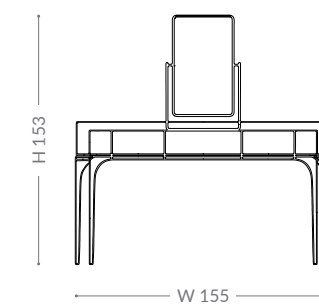

As picture: Mademoiselle dressing table  
In price list: Prime

Lucidatura/Finishing/Отделка/饰面  
85. CHOCOLATE MATT  
70. CANALETTO WALNUT MATT

Parti in metallo/Metal parts/Металлическая фурнитура/金属部件  
HAMMERED GOLD

# MADemoISELLE

CHAIR

Struttura in legno massello. Gambe frontali in noce canaletto. Schienale e seduta decorata con ricamo. Imbottitura in poliuretano a quote differenziate.

Solid wood frame. Canaletto walnut front feet. Quilted backrest and seating. Multiple densities polyurethane foam padding.

Каркас из массива дерева. Передние ножки из древесины ореха каналетто. Стеганая спинка и сиденье. Набивка из пенополиуретана на разной плотности.

实木框架。前脚为卡纳莱托核桃木质座椅面和靠背衍缝装饰。内部填充多种密度聚氨酯泡沫垫料。



DRESSING TABLES

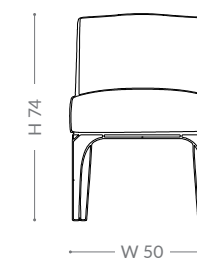

**As picture: Mademoiselle chair**  
In price list: Prestige/Brilliant

Sedia/Chair/Стул/椅子  
BZ 216-120 VELVET RHUBARB

Lucidatura/Finishing/Отделка/饰面  
94. TAUPE  
69. CANALETTO WALNUT

# VIVIEN

DRESSING TABLE

Struttura in legno massello e multistrati di legno. Piedini in legno intagliati a mano. Piano disponibile laccato. Maniglie in ottone. Specchio molato in appoggio.

Solid wood and plywood structure. Hand-carved wooden feet. Top available in lacquered wood. Brass handles. Ground mirror.

Каркас из массива дерева и фанеры. Деревянные ножки ручной работы. Материал столешницы: лакированная древесина. Латунные ручки. Настольное зеркало.

实木和胶合板结构。手工雕刻木腿。桌面为漆木，黄铜把手。卵形镜子。



As picture: Moon Walt pouf  
In price list: Ambition/Brilliant

Pouf/Pouf/Пуф/沙发脚凳  
BZ 901-891 LEATHER IVORY  
Lucidatura/Finishing/Отделка/饰面  
51. SAND

DRESSING TABLES

As picture: Vivien dressing table  
In price list: Brilliant

Lucidatura/Finishing/Отделка/饰面  
51. SAND

Parti in metallo/Metal parts/Металлическая фурнитура/金属部件  
GOLD

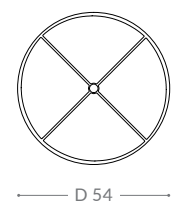
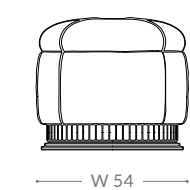
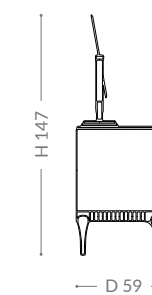
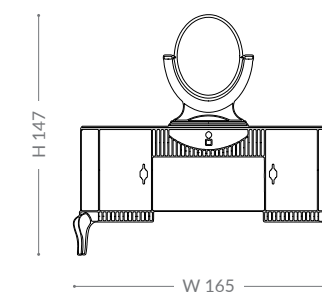



ZB

# BENCHES



# ADAM

BENCH



BENCHES

**As picture: Adam bench**  
In price list: Ambition

Panca/Bench/Банкетка/长凳  
BZ 906-2023 LEATHER CARAMEL

Struttura in legno massello.  
Imbottitura in poliuretano  
a quote differenziate con  
lavorazione *capitoné*.

Solid wood frame. Multiple  
densities polyurethane foam  
padding with *capitoné*  
decoration.

Каркас из массива дерева.  
Набивка из пенополиуретана  
разной плотности, отделка в  
виде каретной стяжки.

实木框架。填充多重密度聚氨酯泡沫，采用分块铆钉装饰。

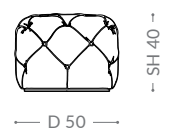
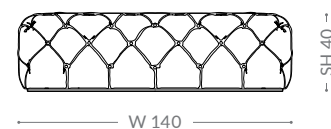

# BLANCA

BENCH 100

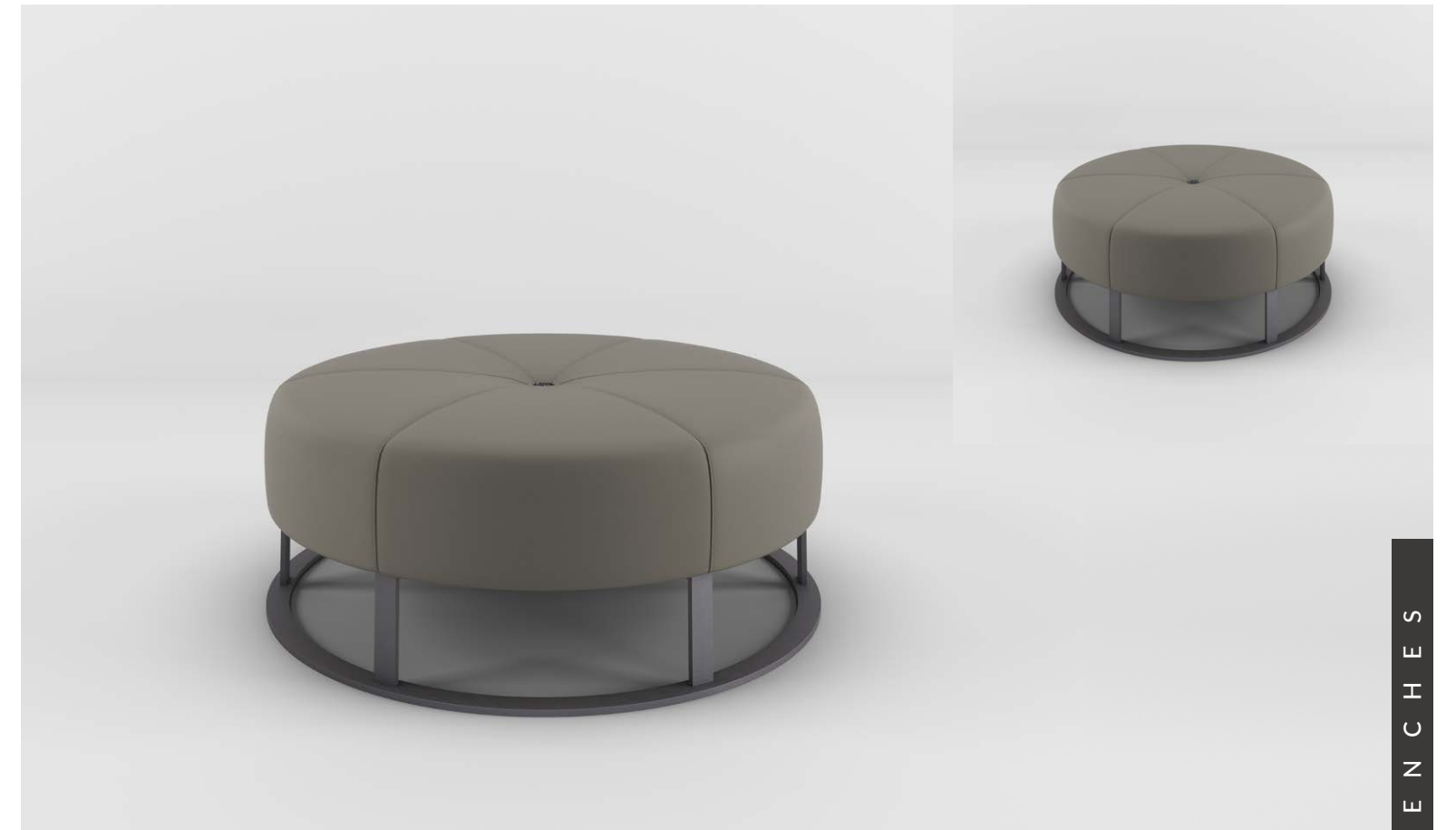

BENCHES

**As picture: Blanca bench 100**  
In price list: Ambition

Panca/Bench/Банкетка/长凳  
BZ 901-702 LEATHER DOVE GREY

Parti in metallo/Metal parts/Металлическая фурнитура/金属部件  
SATIN TITANIUM

Struttura in legno massello;  
basamento in metallo satinato.  
Imbottiture in poliuretano a  
quote differenziate.

Solid wood frame; satin metal  
base. Multiple densities  
polyurethane foam padding.

Каркас из массива дерева,  
основа из сатинированного  
металла. Набивка из  
пенополиуретана разной  
плотности.

实木框架，缎面金属底座。内部填充多种密度聚氨酯泡沫垫料。

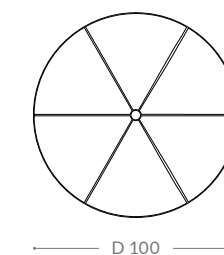
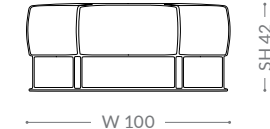

# BLANCA

BENCH 160



BENCHES

**As picture: Blanca bench 160**  
In price list: Prime/Brilliant

Panca/Bench/Банкетка/长凳  
BZ 200-202 VELVET BURGUNDY

Lucidatura/Finishing/Отделка/饰面  
57. CHOCOLATE

Parti in metallo/Metal parts/Металлическая фурнитура/金属部件  
SATIN GOLD

Struttura in legno massello; basamento in metallo satinato. Schienale decorato con ricamo. Imbottiture in poliuretano a quote differenziate.

Solid wood frame; satin metal base. Quilted backrest. Multiple densities polyurethane foam padding.

Каркас из массива дерева, основа из сатинового металла. Стеганая спинка. Набивка из пенополиуретана разной плотности.

实木框架，缎面金属底座。绗缝靠背。内部填充多种密度聚氨酯泡沫垫料。

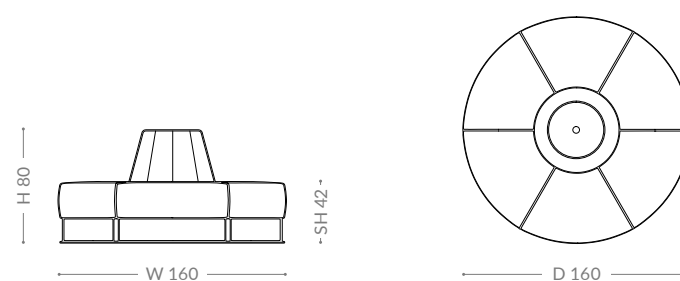

# FAYR

BENCH



BENCHES

**As picture: Fayr bench**  
In price list: Ambition/Brilliant

Panca/Bench/Банкетка/长凳  
BZ 901-432 LEATHER LIGHT BEIGE

Lucidatura/Finishing/Отделка/饰面  
69. CANALETTO WALNUT  
54. GREY

Struttura in multistrati di legno curvato. Piedini in noce canaletto. Seduta decorata con ricamo. Imbottiture in poliuretano a quote differenziate.

Curved plywood frame. Canaletto walnut wooden feet. Quilted seating. Multiple densities polyurethane foam padding.

Каркас из изогнутой фанеры. Ножки из древесины ореха каналетто. Стеганое сиденье. Набивка из пенополиуретана разной плотности.

曲面胶合板结构。前脚为卡纳莱托核桃木质绗缝座椅。内部填充多种密度聚氨酯泡沫垫料。

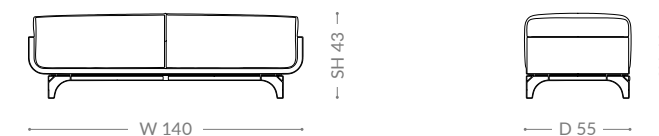



# FLY

BENCH



BENCHES

**As picture: Fly bench**  
In price list: Prime/Brilliant

Panca/Bench/Банкетка/长凳  
BZ 187-127 VELVET SAND

Parti in metallo/Metal parts/Металлическая фурнитура/金属部件  
51. SAND

Struttura in legno massello; basamento in legno di faggio sagomato. Seduta in poliuretano con lavorazione capitonné.

Solid wood frame; shaped beechwood base. Polyurethane foam seating with capitonné decoration.

Каркас из массива дерева, фигурная основа из бука. Сиденье из пенополиуретана украшено каретной стяжкой.

实木框架；山毛榉型材底座。聚氨酯泡沫填充座位，采用分块铆钉装饰。

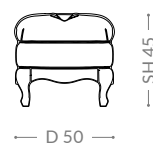
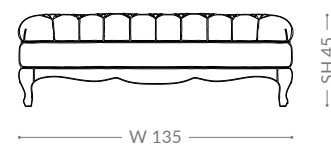

# GREY

BENCH



BENCHES

**As picture: Grey bench**  
In price list: Ambition

Panca/Bench/Банкетка/长凳  
BZ 905-5230 LEATHER GREY

Lucidatura/Finishing/Отделка/饰面  
83. DUST GREY MATT

Struttura in legno massello. Decorata con ricamo. Imbottitura in poliuretano a quote differenziate.

Solid wood frame. Quilted decoration. Multiple densities polyurethane foam padding.

Каркас из массива дерева. Стеганая отделка. Набивка из пенополиуретана разной плотности.

实木框架。绗缝装饰。内部填充多种密度聚氨酯泡沫垫料。

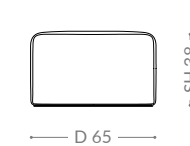
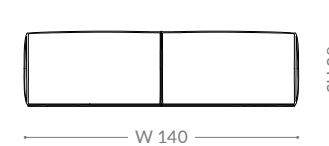

# HERMES

BENCH



BENCHES

**As picture: Hermes bench**  
In price list: Ambition/  
Brilliant

Panca/Bench/Банкетка/长凳  
BZ 901-432 LEATHER LIGHT BEIGE

Lucidatura/Finishing/Отделка/饰面  
88. DIAMOND TITANIUM  
54. GREY

Parti in metallo/Metal parts/  
Металлическая фурнитура/  
金属部件  
TITANIUM

Struttura in legno massello e multistrati di legno. Seduta in poliuretano decorata con ricamo.

Solid wood and plywood frame. Polyurethane foam seating with quilted decoration.

Каркас выполнен из массива дерева и фанеры. Сиденье из пенополиуретана украшено стеганой отделкой.

实木和胶合板框架。座椅内部填充密度聚氨酯泡沫垫料，绗缝装饰

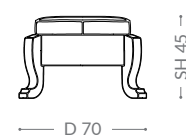

# MOON WALT

BENCH



BENCHES

**As picture: Moon Walt bench**  
In price list: Ambition/Brilliant

Panca/Bench/Банкетка/长凳  
BZ 901-432 LEATHER LIGHT BEIGE

Lucidatura/Finishing/Отделка/饰面  
53. DOVE GREY

Struttura in legno massello; basamento in legno decorato. Parte esterna trapuntata. Imbottitura in poliuretano a quote differenziate.

Solid wood frame; decorated wooden base. Quilted outer body. Multiple densities polyurethane foam padding.

Каркас из массива дерева, деревянная основа с отделкой. Стеганая внешняя часть корпуса. Набивка из пенополиуретана разной плотности.

实木框架；带装饰木制底座。外侧部分绗缝。填充多重密度聚氨酯泡沫。

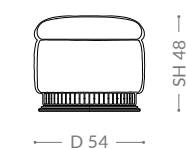
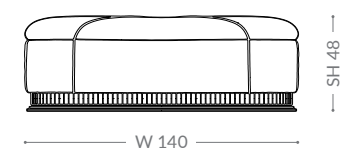



ZB

# CONSOLLES



# KIMBERLY

CONSOLLE

Struttura in multistrati di legno curvato, rivestito in pelle. Gambe frontali in legno di faggio con dettagli metallici. Cassetto in multistrati di legno decorato in pelle ricamata.

Curved plywood frame, covered in leather. Beechwood legs with metal details. Plywood drawer, quilted leather decorated.

Изогнутая фанерная рама, обтянутая кожей. Ножки из бука с металлическими деталями. Выдвижной ящик из фанеры, отделка стеганой кожей.

曲面胶合板框架，采用皮革包裹。山毛榉桌腿配有精细金属装饰。胶合板抽屉，采用绗缝皮革装饰。



CONSOLLES

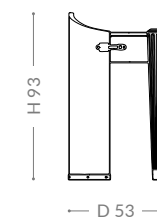
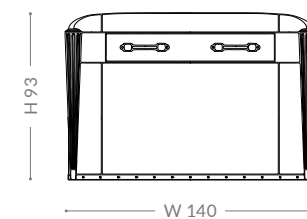

As picture: Kimberly console  
In price list: Brilliant

Lucidatura/Finishing/Отделка/饰面  
94. TAUPE

Parti in metallo/Metal parts/Металлическая фурнитура/金属部件  
GOLD

Materiale/Material/Материал/材料  
BZ 906-2007 LEATHER MOKA

# KIMBERLY

CONSOLLE SMALL



Struttura in multistrati di legno curvato, rivestito in pelle ricamata. Cassetto in multistrati di legno. Dettagli in metallo.

Curved plywood frame, quilted leather covered. Plywood drawer. Metal details.

Изогнутая фанерная рама, обтянутая стеганой кожей. Выдвижной ящик из фанеры. Металлические детали.

曲面胶合板框架，采用绗缝皮革包裹。胶合板抽屉。精细金属配饰。

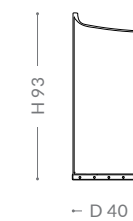
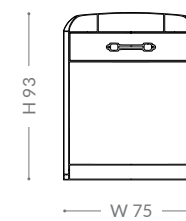

CONSOLLES

As picture: Kimberly console small  
In price list: Brilliant

Lucidatura/Finishing/Отделка/饰面  
96. BURGUNDY

Parti in metallo/Metal parts/Металлическая фурнитура/金属部件  
GOLD

Materiale/Material/Материал/材料  
BZ 906-2030 LEATHER BURGUNDY

# LUCINDA

CONSOLLE

Struttura in metallo satinato e multistrati di legno curvato. Decorazione su cassetto frontale in pelle ricamata.

Satin metal and curved plywood frame. Quilted leather decoration drawer.

Сатинированный металл и изогнутая фанерная рама. Выдвижной ящик с отделкой стеганой кожей.

缎纹金属和曲面胶合板框架。绗缝皮革装饰抽屉。



CONSOLLES

As picture: Lucinda consolle  
In price list: Prime

Lucidatura/Finishing/Отделка/饰面  
81. SAND MATT

Parti in metallo/Metal parts/Металлическая фурнитура/金属部件  
SATIN TITANIUM

Materiale/Material/Материал/材料  
BZ 905-5072 LEATHER CHAMPAGNE

# LUCINDA

CONSOLLE

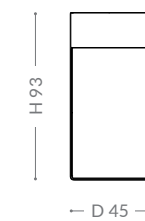
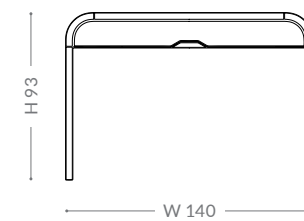

CONSOLLES

As picture: Lucinda console  
In price list: Brilliant

Lucidatura/Finishing/Отделка/饰面  
57. CHOCOLATE

Parti in metallo/Metal parts/Метал-  
лическая фурнитура/金属部件  
SATIN GOLD

Materiale/Material/Материал/材料  
BZ 906-2003 LEATHER DARK BROWN

# RANDOLPH

CONSOLLE

Struttura in legno massello e metallo. Parte centrale in pelle ricamata. Piano disponibile in essenza di ebano makassar con inserto in marmo.

Solid wood and metal frame. Quilted leather decoration. Top available in makassar ebony veneer with marble inlay.

Рама из массива дерева и металла. Отделка стеганой кожей. Доступные материалы столешницы: шпон макаassarского эбена с мраморной инкрустацией.

实木与金属框架。绗缝皮革装饰。桌面为大理石镶嵌的望加锡乌木饰面。

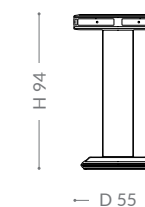
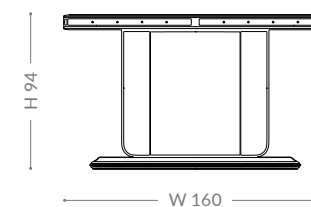
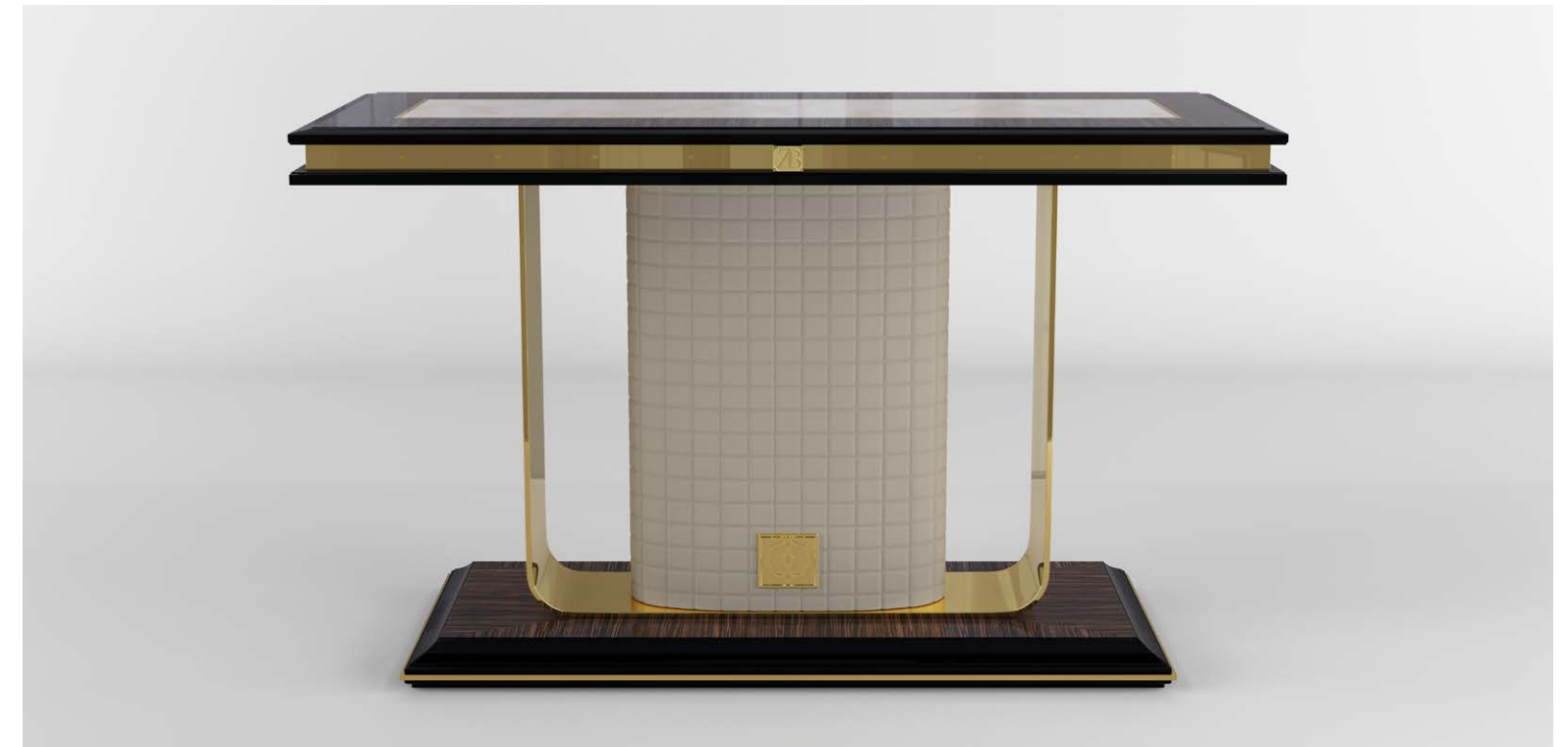
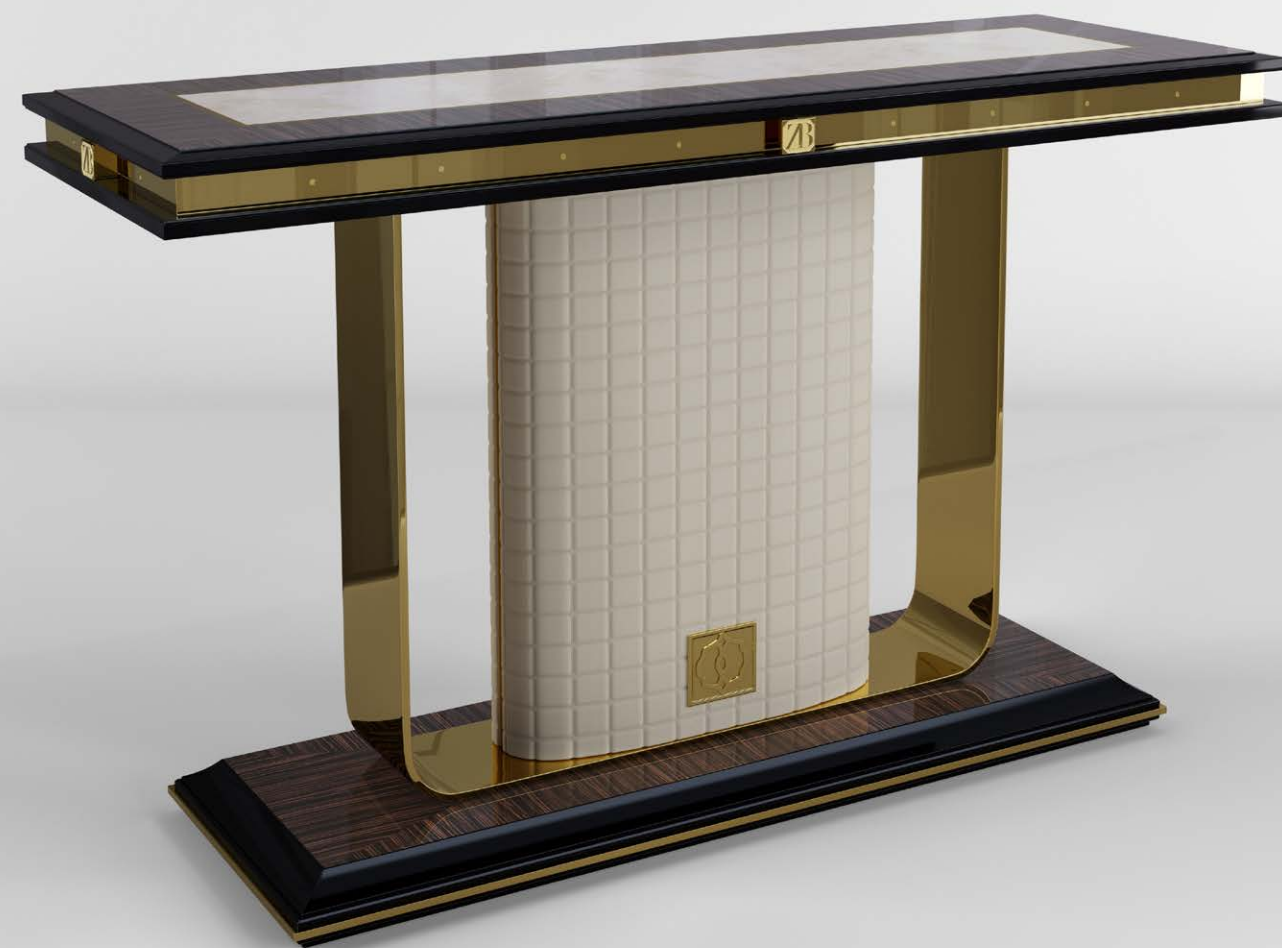

CONSOLLES

As picture: Randolph console  
In price list: Brilliant/Onyx

Lucidatura/Finishing/Отделка/饰面  
57. CHOCOLATE  
65. MAKASSAR

Parti in metallo/Metal parts/Металлическая фурнитура/金属部件  
GOLD

Marmo/Marble/Мрамор/大理石  
ONYX HONEY  
Materiale/Material/Материал/材料  
BZ 901-332 LEATHER BUTTER



# SWING

BACKSOFA CONSOLLE

Struttura in legno massello.  
Decorazioni in metallo laccate.  
Piano disponibile in essenza di  
noce canaletto o marmo.

Solid wood frame. Lacquered  
metal decorations. Top  
available in canaletto wooden  
veneer or marble.

Рама из массива дерева.  
Украшения из полированного  
металла. Доступные  
материалы столешницы:  
шпон ореха каналетто или  
мрамор.

实木框架，点缀漆面金属装  
饰。台面可选卡纳莱托木饰板  
或大理石

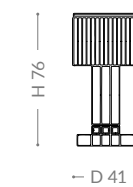
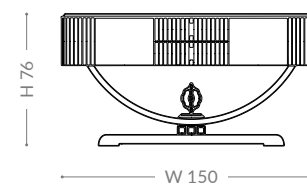

CONSOLLES

As picture: Swing backsofa consolle  
In price list: Brilliant

Lucidatura/Finishing/Отделка/饰面  
51. SAND  
64. CANALETTO WALNUT

Parti in metallo/Metal parts/Метал-  
лическая фурнитура/金属部件  
61. DIAMOND GOLD

# SWING

CONSOLLE LARGE



Struttura in legno massello, multistrati di legno e metallo laccato. Piano disponibile in legno laccato, essenza di noce canaletto o marmo.

Solid wood frame, plywood and lacquered metal. Top available in lacquered wood, canaletto wooden veneer or marble.

Рама из массива дерева, фанеры и полированного металла. Доступные материалы столешницы: лакированная древесина, шпон ореха каналетто или мрамор.

实木框架，胶合板和喷漆金属。桌面可选用漆木、卡纳莱托胡桃木饰面或大理石。

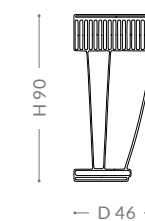
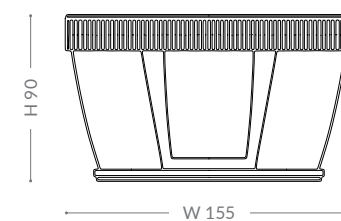

CONSOLLES

As picture: Swing console large  
In price list: Brilliant/  
Precious stone

Lucidatura/Finishing/Отделка/饰面  
51. SAND

Marmo/Marble/Мрамор/大理石  
EMPERADOR LIGHT

Parti in metallo/Metal parts/Металлическая фурнитура/金属部件  
61. DIAMOND GOLD

# SWING

CONSOLLE SMALL

Struttura in legno massello, multistrati di legno e metallo laccato. Piano disponibile in legno laccato, essenza di noce canaletto o marmo.

Solid wood frame, plywood and lacquered metal. Top available in lacquered wood, canaletto wooden veneer or marble.

Рама из массива дерева, фанеры и полированного металла. Доступные материалы столешницы: лакированная древесина, шпон ореха каналетто или мрамор.

实木框架，胶合板和喷漆金属。桌面可选用漆木、卡纳莱托胡桃木饰面或大理石。

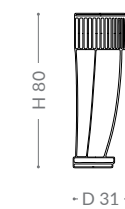
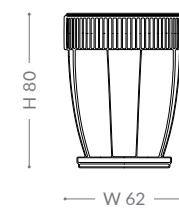

As picture: Swing console small  
In price list: Brilliant/Precious stone

Lucidatura/Finishing/Отделка/饰面  
58. BLACK

Marmo/Marble/Мрамор/大理石  
BLACK&GOLD

# WANDA

CONSOLLE

Struttura in legno massello, multistrati di legno e metallo martellato. Piano disponibile in radica di noce.

Solid wood frame, plywood and hammered metal. Top available in canaletto walnut briar root.

Рама из массива дерева, фанеры и кованого металла. Столешница из ореха каналетто и бриара.

实木框架，胶合板和锤纹金属。桌面为卡纳莱托胡桃木石南根。

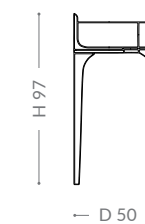
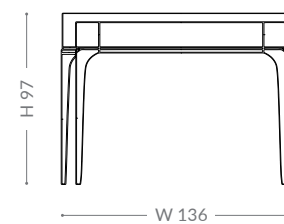

As picture: Wanda consolle  
In price list: Brilliant

Lucidatura/Finishing/Отделка/饰面  
71. WALNUT BRIAR ROOT  
57. CHOCOLATE

Parti in metallo/Metal parts/Металлическая фурнитура/金属部件  
HAMMERED GOLD

# WANDA

CONSOLLE SMALL

Struttura in legno massello, multistrati di legno e metallo martellato. Piano disponibile in essenza di noce canaletto.

Solid wood frame, plywood and hammered metal. Top available canaletto wooden veneer.

Рама из массива дерева, фанеры и кованого металла. Деревянная столешница из шпона ореха каналетто.

实木框架，胶合板和锤纹金属。桌面为卡纳莱托实木饰面。

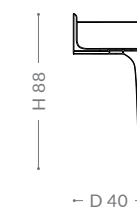
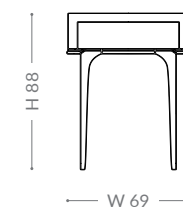

CONSOLLES

As picture: Wanda consolle small  
In price list: Prime

Lucidatura/Finishing/Отделка/饰面  
93. WENGÉ MATT  
100. GREY MATT

Parti in metallo/Metal parts/Металлическая фурнитура/金属部件  
HAMMERED GOLD



# CONCORDE

SIDEBOARD



Struttura in legno massello e multistrati di legno. Dettagli maniglia e base in metallo. Piano e ante disponibili in essenza di noce canaletto o ebano makassar.

Solid wood and plywood frame. Metal handle details and base. Top and doors available in canaletto walnut and makassar ebony veneer.

Рама из массива дерева и фанеры. Металлические детали ручек и основа. Доступные материалы столешницы и дверок: шпон ореха каналетто и макаassarского эбена.

实木胶合板框架。金属把手配饰和底座。台面和柜门可选用卡纳莱托胡桃木饰面和望加锡乌木饰面。

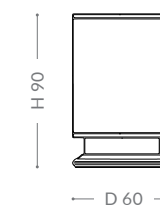
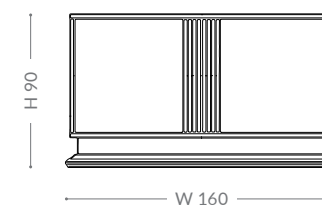

SIDEBOARDS

As picture: Concorde sideboard  
In price list: Brilliant

Lucidatura/Finishing/Отделка/饰面  
53. DOVE GREY  
63. WHITENED CANALETTO WALNUT

Parti in metallo/Metal parts/Металлическая фурнитура/金属部件  
GOLD

# CONCORDE

SIDEBOARD WIDE



SIDEBOARDS

As picture: Concorde sideboard wide  
In price list: Brilliant

Lucidatura/Finishing/Отделка/饰面  
65. MAKASSAR  
57. CHOCOLATE

Parti in metallo/Metal parts/Металлическая фурнитура/金属部件  
GOLD

Struttura in legno massello e multistrati di legno. Dettagli maniglia e base in metallo. Piano e ante disponibili in essenza di noce canaletto o ebano makassar.

Solid wood and plywood frame. Metal handle details and base. Top and doors available in canaletto walnut and makassar ebony veneer.

Рама из массива дерева и фанеры. Металлические детали ручек и основа. Доступные материалы столешницы и дверок: шпон ореха каналетто и макаassarского эбена.

实木胶合板框架。金属把手配饰和底座。台面和柜门可选用卡纳莱托胡桃木饰面和望加锡乌木饰面。

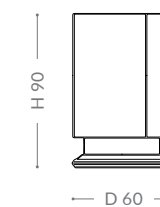
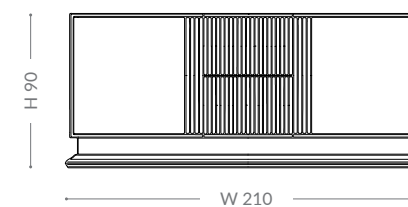



# DEANNA

SIDEBOARD 9 DRAWERS

Struttura in legno massello e multistrati di legno. Disponibile in essenza di noce canaletto. Piedini frontali e maniglie in metallo satinato.

Solid wood and plywood frame. Available in canaletto walnut veneer. Satin metal frontal feet and handles.

Рама из массива дерева и фанеры. Доступный материал: шпон ореха каналетто. Передние ножки и ручки из сатинированного металла.

实木胶合板框架，卡纳莱托胡桃木饰面。正面柜脚和把手采用缎纹金属。

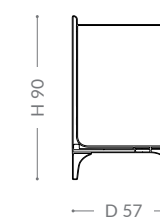
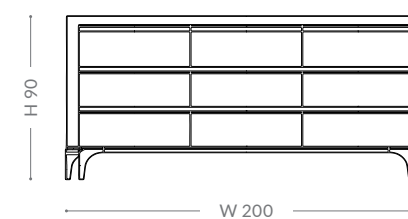

As picture: Deanna sideboard  
9 drawers  
In price list: Prime

Lucidatura/Finishing/Отделка/饰面  
70. CANALETTO WALNUT MATT  
85. CHOCOLATE MATT

Parti in metallo/Metal parts/Металлическая фурнитура/金属部件  
SATIN TITANIUM

# DEANNA

SIDEBOARD 3 DRAWERS

Struttura in legno massello e multistrati di legno. Disponibile in essenza di noce canaletto. Piedini frontali e maniglie in metallo satinato.

Solid wood and plywood frame. Available in canaletto walnut veneer. Satin metal frontal feet and handles.

Рама из массива дерева и фанеры. Доступный материал: шпон ореха каналетто. Передние ножки и ручки из сатинированного металла.

实木胶合板框架，卡纳莱托胡桃木饰面。正面柜脚和把手采用缎纹金属。

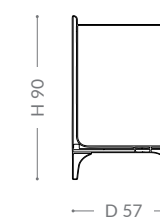
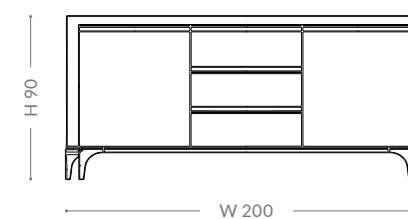

As picture: Deanna sideboard  
3 drawers  
In price list: Brilliant

Lucidatura/Finishing/Отделка/饰面  
98. WENGÉ  
53. DOVE GREY

Parti in metallo/Metal parts/Металлическая фурнитура/金属部件  
SATIN GOLD

# DUKE

SIDEBOARD



Struttura in legno massello e multistrati di legno. Piedini in legno intagliati a mano. Piano disponibile in essenza di noce canaletto o marmo. Maniglie in ottone.

Solid wood and plywood frame. Hand-carved feet. Top available in canaletto walnut veneer or marble. Brass handles.

Рама из массива дерева и фанеры. Ножки ручной работы. Доступные материалы столешницы: шпон ореха каналетто или мрамор. Латунные ручки.

实木胶合板框架。柜脚为手工雕刻。餐柜台面可选用卡纳莱托胡桃木饰面或大理石。黄铜把手。

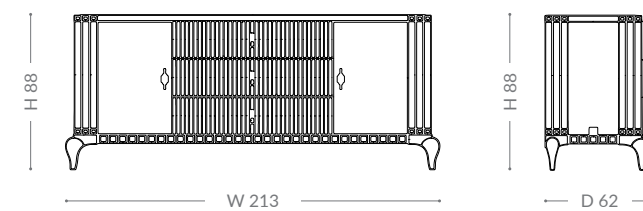

SIDEBOARDS

As picture: Duke sideboard  
In price list: Brilliant/  
Precious stone

Lucidatura/Finishing/Отделка/饰面  
51. SAND  
64. CANALETTO WALNUT

Marmo/Marble/Мрамор/大理石  
EMPERADOR LIGHT

Parti in metallo/Metal parts/Металлическая фурнитура/金属部件  
GOLD

# FIORILE

SIDEBOARD



Struttura in metallo satinato e multistrati di legno curvato. Disponibile in legno laccato. Decorazione su cassetti e ante frontali in pelle ricamata.

Satin metal and curved plywood frame. Available in lacquered wood. Quilted leather drawers and doors.

Сатинированный металл и изогнутая фанерная рама. Доступный материал: лакированная древесина. Выдвижные ящики и дверцы, обшитые стеганой кожей.

缎纹金属和曲面胶合板框架。漆木质地。抽屉和柜门采用绗缝皮革。



SIDEBOARDS

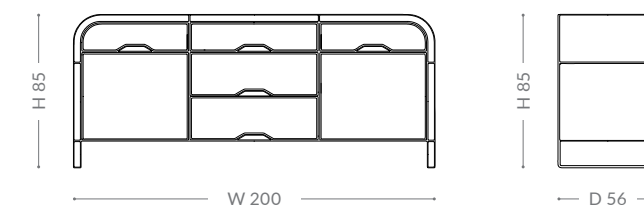

As picture: Fiorile sideboard  
In price list: Brilliant

Lucidatura/Finishing/Отделка/饰面  
54. GREY

Parti in metallo/Metal parts/Металлическая фурнитура/金属部件  
SATIN GOLD

Materiale/Material/Материал/材料  
BZ 906-2006 LEATHER TAUPE

# GLENN

SIDEBOARD HIGH

Struttura in legno massello e multistrati di legno. Piano e ante disponibili in essenza di ebano makassar o erable grigio. Fronte cassetti decorati in pelle ricamata. Maniglie in ottone.

Solid wood and plywood frame. Top and doors available in makassar ebony or grey erable veneer. Quilted leather drawers. Brass handles.

Рама из массива дерева и фанеры. Доступный материал столешницы и дверей: шпон макассарского эбена или шпон серого клена. Выдвижные ящики из стеганой кожи. Латунные ручки.

实木胶合板框架。台面和柜门可选用孟加锡乌木饰面或灰雀眼木饰面。绗缝皮革抽屉。黄铜把手。

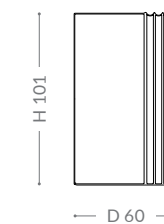
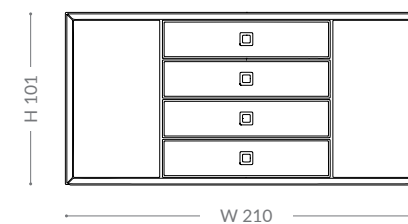

SIDEBOARDS

As picture: Glenn sideboard high  
In price list: Brilliant

Lucidatura/Finishing/Отделка/饰面  
65. MAKASSAR  
57. CHOCOLATE

Parti in metallo/Metal parts/Металлическая фурнитура/金属部件  
GOLD

Materiale/Material/Материал/材料  
BZ 901-891 LEATHER IVORY

# GLENN

SIDEBOARD LOW



Struttura in legno massello e multistrati di legno. Piano e ante disponibili in essenza di ebano makassar o erable grigio. Fronte cassetti decorati in pelle ricamata. Maniglie in ottone.

Solid wood and plywood frame. Top and doors available in makassar ebony or grey erable veneer. Quilted leather drawers. Brass handles.

Рама из массива дерева и фанеры. Доступный материал столешницы и дверей: шпон макассарского эбена или шпон серого клена. Выдвижные ящики из стеганой кожи. Латунные ручки.

实木胶合板框架。台面和柜门可选用孟加锡乌木饰面或灰雀眼木饰面。绗缝皮革抽屉。黄铜把手。

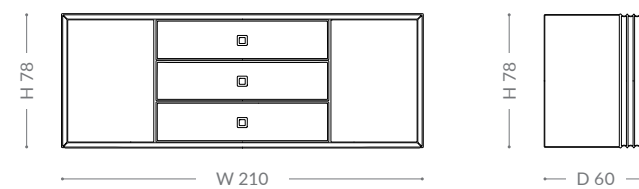
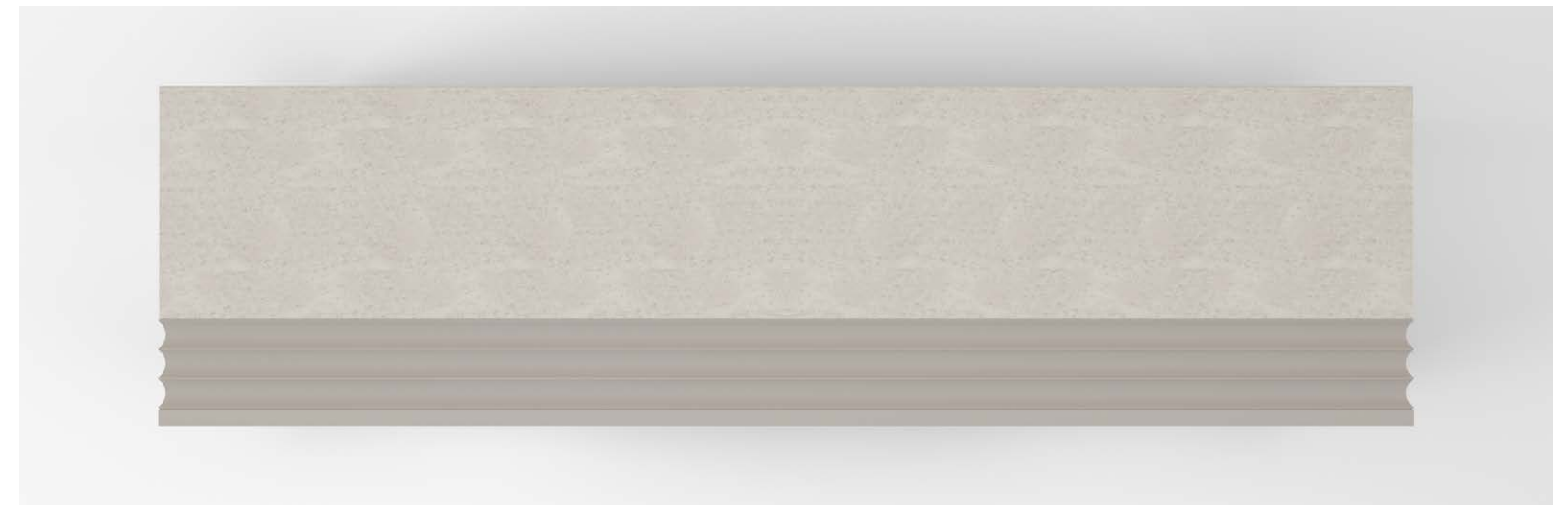

SIDEBOARDS

As picture: Glenn sideboard low  
In price list: Brilliant

Lucidatura/Finishing/Отделка/饰面  
53. DOVE GREY  
74. ERABLE GREY

Parti in metallo/Metal parts/Металлическая фурнитура/金属部件  
TITANIUM

Materiale/Material/Материал/材料  
BZ 901-432 LEATHER LIGHT BEIGE

# REMINGTON

SIDEBOARD

Struttura in legno massello, multistrati di legno e MDF. Piano in legno laccato. Parte laterale e cassetti decorati in pelle ricamata. Dettagli e maniglie in ottone. Colonne decorative in legno con fresature verticali.

Solid wood, plywood and MDF frame. Lacquered wooden top. Quilted leather side parts and drawers. Brass handles and details. Wooden columns with fluted decorations.

Рама из массива дерева, фанеры и МДФ. Столешница из лакированной древесины. Боковые части и выдвижные ящики из стеганой кожи. Латунные ручки и детали. Деревянные опоры с рифлеными украшениями.

实木、胶合板、以及中密度纤维板 (MDF) 框架。漆木桌面。侧面部件和抽屉采用绗缝皮革。黄铜把手和配饰。木制柜体带有凹槽装饰。

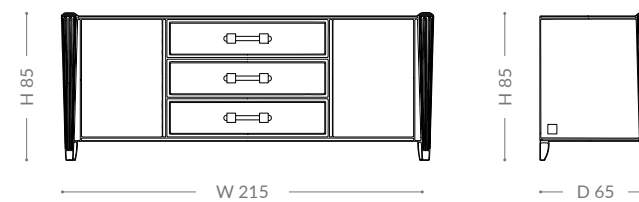

SIDEBOARDS

As picture: Remington sideboard  
In price list: Brilliant

Lucidatura/Finishing/Отделка/饰面  
51. SAND

Parti in metallo/Metal parts/Металлическая фурнитура/金属部件  
GOLD

Materiale/Material/Материал/材料  
BZ 901-891 LEATHER IVORY





# CONCORDE

TV FRAME



Struttura in legno massello e multistrati di legno. Cornice frontale disponibile in essenza di erable grigio, ebano makassar o noce canaletto. Parte interna decorata in pelle ricamata.

Solid wood and plywood structure. Front profile available in grey erable, makassar ebony or canaletto walnut veneer. Quilted leather inner body.

Каркас из массива дерева и фанеры. Доступные материалы: шпон серого клена, макассарского эбена или ореха каналетто. Внутренние поверхности отделана стеганой кожей.

实木和胶合板结构。前侧柜体可选用灰雀眼木饰面、孟加锡乌木饰面或卡纳莱托胡桃木饰面。内部框架采用绗缝皮革。

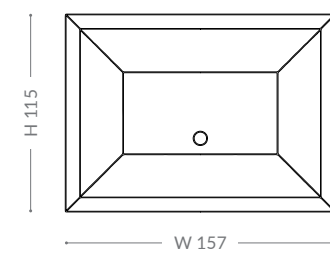
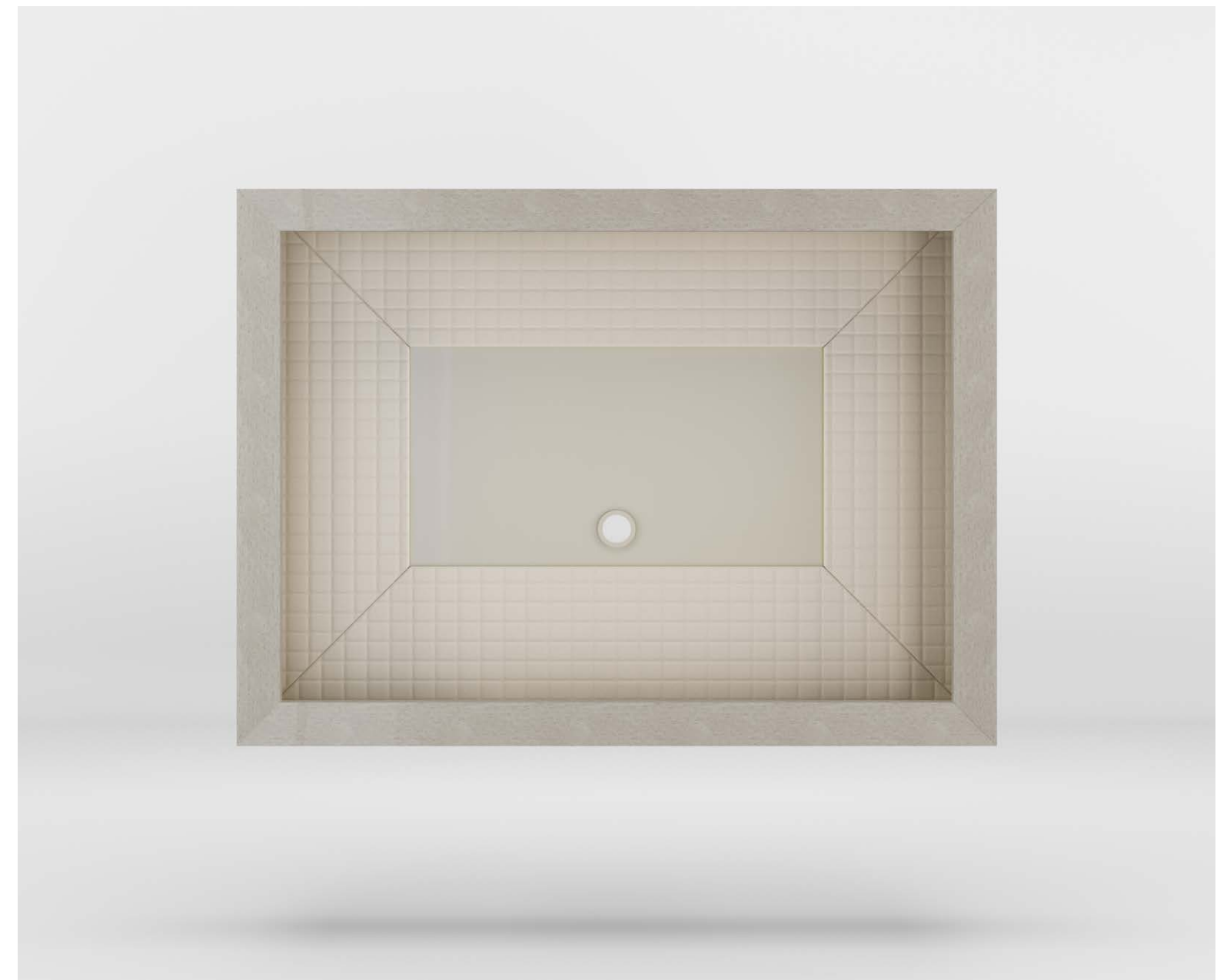

As picture: Concorde Tv frame  
In price list: Brilliant

Lucidatura/Finishing/Отделка/饰面  
53. DOVE GREY  
74. ERABLE GREY

Materiale/Material/Материал/材料  
BZ 901-891 LEATHER IVORY

# CONCORDE

TV CABINET

Struttura in legno massello e multistrati di legno. Cornice frontale e cassetti disponibili in essenza di erable grigio, ebano makassar o noce canaletto. Dettagli base e maniglie in ottone.

Solid wood and plywood structure. Front profile and drawers available in grey erable, makassar ebony or canaletto walnut veneer. Handles and base details in brass.

Каркас из массива дерева и фанеры. Доступные материалы: шпон серого клена, макаassarского эбена или ореха каналетто. Латунные ручки и опорные детали.

实木和胶合板结构。前侧柜体和抽屉可选用灰雀眼木饰面、孟加锡乌木饰面或卡纳莱托胡桃木饰面。把手和底座配饰采用黄铜。



T  
V  
U  
N  
I  
T  
S

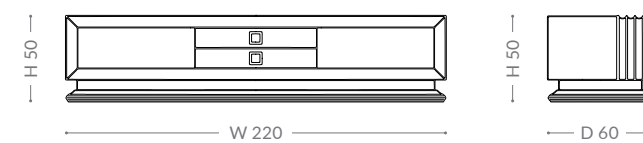

**As picture: Concorde Tv cabinet**  
In price list: Brilliant

Lucidatura/Finishing/Отделка/饰面  
53. DOVE GREY  
74. ERABLE GREY

Parti in metallo/Metal parts/Металлическая фурнитура/金属部件  
TITANIUM

# DUCA

TV FRAME

Cornice in noce canaletto massello. Pannello interno in multistrati di legno, decorato in pelle ricamata. Parte centrale in legno laccato.

Canaletto walnut solid outer frame. Plywood back panel, decorated with quilted leather; central part in lacquered finishing.

Каркас из массива ореха каналетто. Задняя панель из фанеры, отделанная стеганой кожей, лакированная средняя часть.

卡纳莱托胡桃木实木外框。胶合板背板，绗缝皮革装饰；中部喷漆加工。

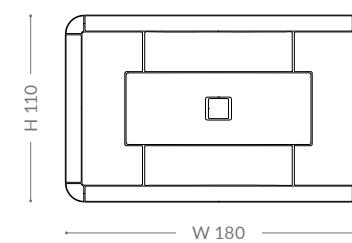

T  
V  
U  
N  
I  
T  
S

As picture: Duca Tv frame  
In price list: Brilliant

Lucidatura/Finishing/Отделка/饰面  
69. CANALETTO WALNUT  
100. GREY MATT

Materiale/Material/Материал/材料  
BZ 906-2005 LEATHER OASI

# DUCA

TV CABINET

Struttura in legno massello e multistrati di legno. Struttura superiore disponibile in essenza di noce canaletto. Piedini frontali e maniglie in metallo satinato. Ripiano in cristallo color bronzo.

Solid wood and plywood structure. Upper structure available in canaletto walnut veneer. Satin metal front feet and handles. Crystal shelf, bronze colour.

Каркас из массива дерева и фанеры. Верхняя часть каркаса из шпона ореха каналетто. Передние ножки и ручки из satinированного металла. Хрустальной полкой, бронзового цвета.

实木和胶合板结构。上部结构为卡纳莱托胡桃木饰面。缎纹金属前柜脚和把手。水晶陈列架，青铜色。



T  
V  
U  
N  
I  
T  
S

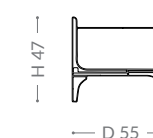
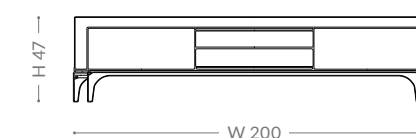

As picture: Duca Tv cabinet  
In price list: Brilliant

Lucidatura/Finishing/Отделка/饰面  
54. GREY  
69. CANALETTO WALNUT

Parti in metallo/Metal parts/Металлическая фурнитура/金属部件  
SATIN GOLD

Vetro/Glass/Стекло/изделие/玻璃  
BRONZE

# DUKE

TV FRAME

Cornice in legno massello, pannello in multistrati di legno. Parte interna con decorazione a traforo e tessuto.

Solid wood structure and plywood back panel. Internal framing with fretwork decoration and fabric.

Каркас из массива дерева и задняя панель из фанеры. Внутренняя поверхность украшена резной отделкой и текстилем.

实木结构和胶合板背板。内部框架采用浮雕装饰和织物装饰。

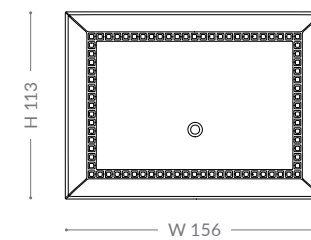
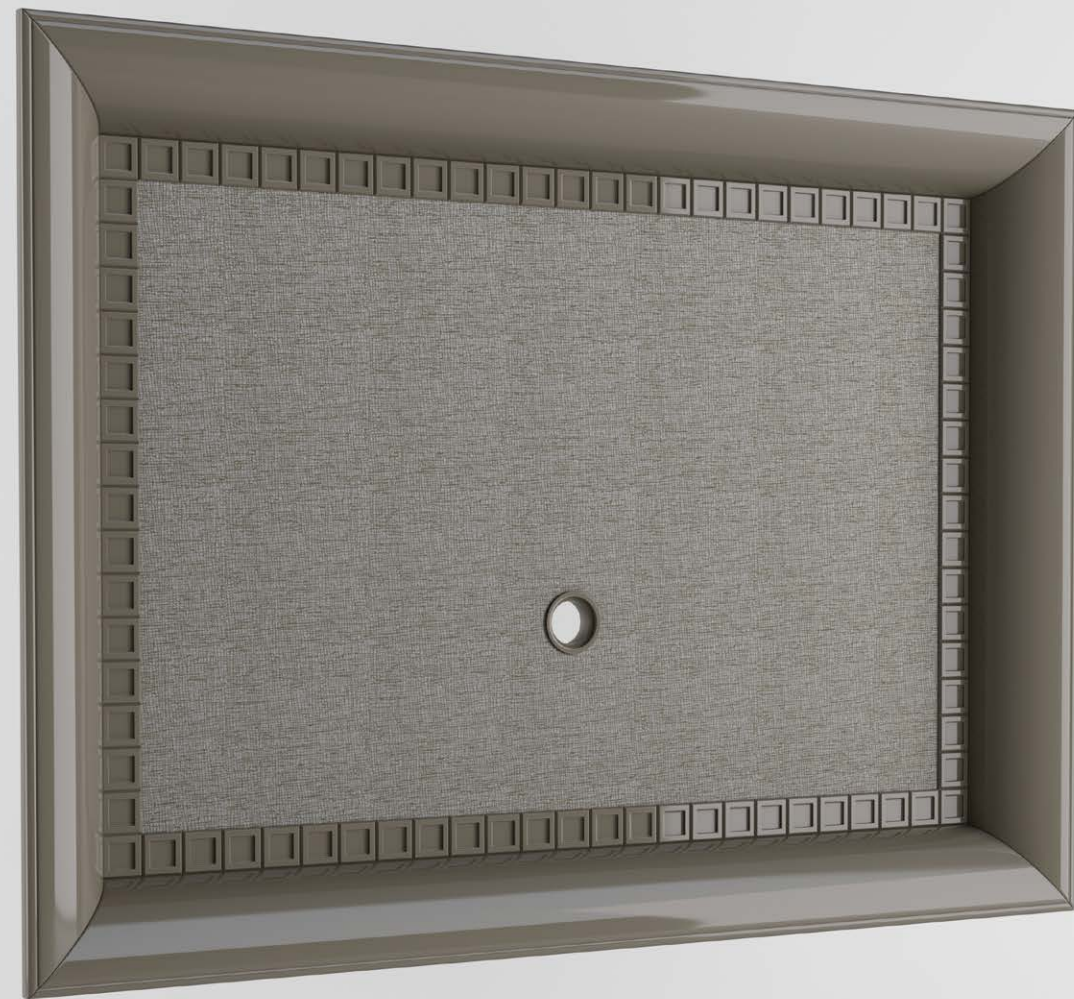

T  
V  
U  
N  
I  
T  
S

As picture: Duke Tv frame  
In price list: Brilliant

Lucidatura/Finishing/Отделка/饰面  
54. GREY

Materiale/Material/Материал/材料  
BZ 126-51 UNITO GREY/PEARL

# DUKE

TV CABINET



T  
V  
U  
N  
I  
T  
S

Struttura in legno massello e multistrati di legno. Piedini in legno intagliati a mano. Piano disponibile in essenza di noce canaletto o marmo. Maniglie in ottone.

Solid wood and plywood structure. Hand-carved wooden legs. Top available in canaletto walnut veneer or marble. Brass handles.

Каркас из массива дерева и фанеры. Резные деревянные ножки ручной работы. Доступные материалы столешницы: шпон ореха каналетто или мрамор. Латунные ручки.

实木和胶合板结构。木制柜脚采用手工雕刻。电视柜台面可选用卡纳莱托胡桃木饰面或大理石。黄铜把手。

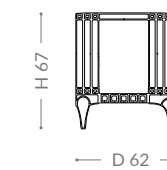
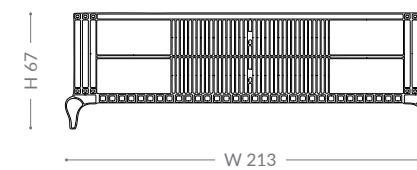

As picture: Duke Tv cabinet  
In price list: Brilliant

Lucidatura/Finishing/Отделка/饰面  
54. GREY  
64. CANALETTO WALNUT

Parti in metallo/Metal parts/Металлическая фурнитура/金属部件  
88. DIAMOND TITANIUM

# FIORILE

TV CABINET

Struttura in metallo satinato e multistrati di legno curvato. Disponibile in legno laccato. Decorazione su cassetti frontali in pelle ricamata.

Satin metal and curved plywood structure. Available in lacquered wood. Quilted leather front drawers.

Каркас из сатинированного металла и изогнутой фанеры. Материал: лакированная древесина. Фасады выдвижных ящиков отделаны стеганой кожей.

缎纹金属和曲面胶合板结构。漆木质地。前部抽屉采用绗缝皮革。



TV UNITS

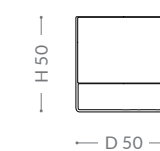
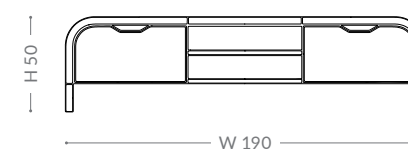

As picture: Fiorile Tv cabinet  
In price list: Brilliant

Lucidatura/Finishing/Отделка/饰面  
94. TAUPE

Parti in metallo/Metal parts/Металлическая фурнитура/金属部件  
SATIN GOLD

Materiale/Material/Материал/材料  
BZ 906-2007 LEATHER MOKA

# REMINGTON

TV FRAME



Struttura in multistrati di legno. Profili perimetrali in metallo. Cornice decorata in pelle ricamata. Parte interna disponibile in essenza di ebano makassar.

Plywood structure. Metal profiles. Quilted leather framework. Back panel available in makassar ebony veneer.

Каркас из фанеры. Металлические профили. Рамка из стеганой кожи. Задняя панель из шпона макассарского эбена.

胶合板结构。金属柜体。绗缝皮革框架。孟加锡乌木饰面背板。

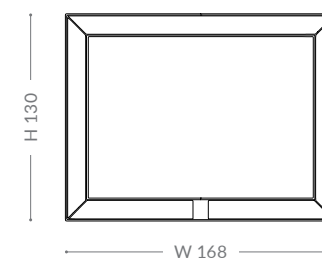

T  
V  
U  
N  
I  
T  
S

As picture: Remington Tv frame  
In price list: Brilliant

Lucidatura/Finishing/Отделка/饰面  
65. MAKASSAR

Parti in metallo/Metal parts/Металлическая фурнитура/金属部件  
GOLD

Materiale/Material/Материал/材料  
BZ 901-332 LEATHER BUTTER



# REMINGTON

TV CABINET



Struttura in legno massello, multistrati di legno e MDF. Piano, fianco e cassetti decorati in pelle ricamata. Profili e maniglie in metallo. Colonne decorative in legno con dettagli in ottone.

Solid wood, plywood and MDF structure. Quilted leather outer structure and drawers. Metal handles and profiles. Wooden columns, with brass decoration.

Каркас из массива дерева, фанеры и МДФ. Наружные поверхности и выдвижные ящики отделаны стеганой кожей. Металлические ручки и профили. Деревянные ножки-колонны с латунной отделкой.

实木、胶合板和中密度纤维板结构。外部结构和抽屉采用绗缝皮革。金属把手和柜体。木制支柱带有黄铜装饰。

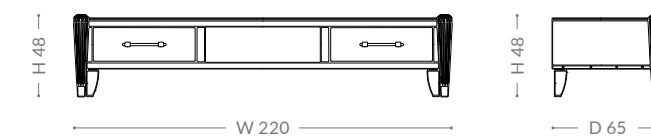

T  
V  
U  
N  
I  
T  
S

As picture: Remington Tv cabinet  
In price list: Brilliant

Lucidatura/Finishing/Отделка/饰面  
50. IVORY

Parti in metallo/Metal parts/Металлическая фурнитура/金属部件  
GOLD

Materiale/Material/Материал/材料  
BZ 901-332 LEATHER BUTTER



ZB

DISPLAY  
CABINETS



# CONCORDE

DISPLAY CABINET



Struttura in legno massello e multistrati di legno. Disponibile in essenza di erable grigio, ebano makassar o noce canaletto. Ante in legno massello e vetro extrawhite. Maniglie in metallo. Parte interna con ripiani in cristallo e schienale a specchio bronzo.

Solid wood and plywood structure. Available in grey erable, makassar ebony or canaletto walnut veneer. Solid wood doors, extrawhite glass. Metal handles. Internally fitted with crystal shelves and bronze mirror back panel.

Каркас из массива дерева и фанеры. Доступные материалы: шпон серого клена, макассарского эбена или ореха канаletto. Двери из массива дерева и бесцветного просветленного стекла. Металлические ручки. Внутри установлены хрустальные полки и зеркальная задняя панель бронзового оттенка.

实木和胶合板结构。可选灰雀眼木饰面、孟加锡乌木饰面或卡纳莱托胡桃木饰面。实木柜门，外配白色玻璃。金属把手。内部配有水晶陈列架和铜镜背板。

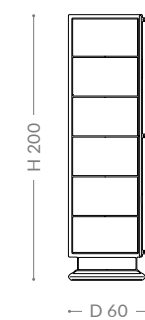
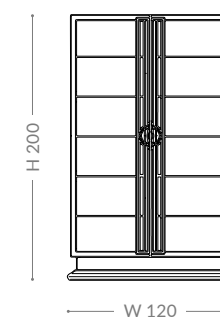

DISPLAY CABINETS

As picture: Concorde display cabinet  
In price list: Brilliant

Lucidatura/Finishing/Отделка/饰面  
53. DOVE GREY  
74. ERABLE GREY

Parti in metallo/Metal parts/Металлическая фурнитура/金属部件  
TITANIUM

# ESTELLE

DISPLAY CABINET

Struttura in metallo e legno.  
Parte esterna decorata in  
pelle ricamata. Parte interna  
laccata, ripiani in cristallo  
illuminati a LED e schienale in  
pelle ricamata. Ante in vetro  
temperato e maniglia in ottone.

Metal and wooden structure.  
Quilted leather outer body.  
Lacquered inner body, LED  
lighting crystal shelves, quilted  
leather back panel. Tempered  
glass doors with brass handles.

Каркас из металла и дерева.  
Выполнена наружная отделка  
стеганой кожей. Лакирован-  
ная внутренняя поверхность,  
хрустальные полки со свето-  
диодной подсветкой, задняя  
панель отделана стеганой  
кожей. Двери из закаленного  
стекла с латунными ручками.

金属木制结构。外部为绗缝皮  
革。内部喷漆，LED 照明水晶  
陈列架，绗缝皮革背板。钢化  
玻璃门带有黄铜把手。

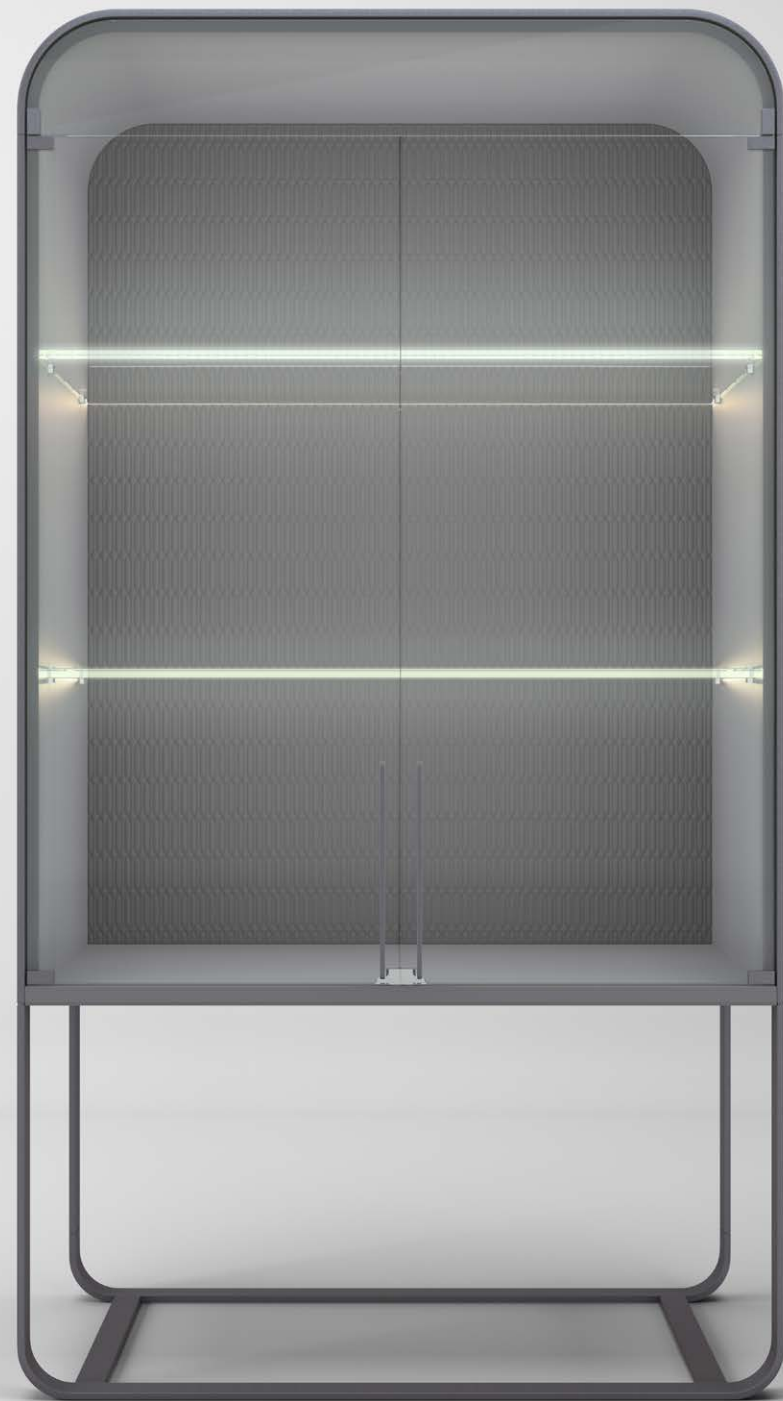

DISPLAY CABINETS

As picture: Estelle  
display cabinet  
In price list: Prime

Lucidatura/Finishing/Отделка/饰面  
82. LIGHT GREY MATT

Parti in metallo/Metal parts/Метал-  
лическая фурнитура/金属部件  
SATIN TITANIUM

Materiale/Material/Материал/材料  
BZ 905-5230 LEATHER GREY

# ESTELLE

DISPLAY CABINET



DISPLAY CABINETS

As picture: Estelle display cabinet  
In price list: Prime

Lucidatura/Finishing/Отделка/饰面  
85. CHOCOLATE MATT

Parti in metallo/Metal parts/Металлическая фурнитура/金属部件  
SATIN GOLD

Materiale/Material/Материал/材料  
BZ 906-2003 LEATHER DARK BROWN

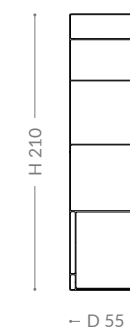
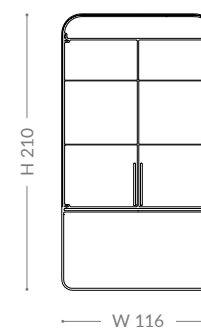

# FRITZ

DISPLAY CABINET

Struttura in legno massello; gambe in legno intagliate a mano. Parte interna con ripiani in vetro; schienale in tessuto. Ante in vetro temperato con maniglie in ottone.

Solid wood structure; hand-carved legs. Internally fitted with glass shelves and fabric back panel. Tempered glass doors with brass handles.

Каркас из массива дерева; резные ножки ручной работы. Внутри установлены стеклянные полки, задняя панель отделана текстилем. Двери из закаленного стекла с латунными ручками.

实木结构；柜脚采用手工雕刻。内部配有玻璃陈列架和织物背板。钢化玻璃门带有黄铜把手。



DISPLAY CABINETS

As picture: Fritz display cabinet  
In price list: Prime

Lucidatura/Finishing/Отделка/饰面  
55. COFFEE

Parti in metallo/Metal parts/Металлическая фурнитура/金属部件  
GOLD

Materiale/Material/Материал/材料  
BZ 184-901 PALMA BEIGE/IVORY

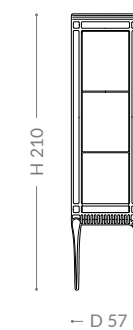
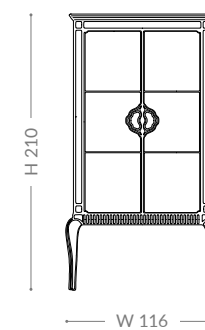

# KIMBERLY

DISPLAY CABINET



DISPLAY CABINETS

As picture: Kimberly display cabinet  
In price list: Brilliant

Lucidatura/Finishing/Отделка/饰面  
51. SAND

Parti in metallo/Metal parts/Металлическая фурнитура/金属部件  
GOLD

Materiale/Material/Материал/材料  
BZ 901-891 LEATHER IVORY

Struttura in multistrati di legno curvato, rivestito in pelle. Gambe frontali in legno di faggio e dettagli metallici. Ante in vetro intagliato, ripiani in vetro. Schienale in essenza di ebano makassar e illuminazione LED. Maniglie in metallo.

Curved plywood structure, covered in leather. Beechwood legs with metal details. Carved glass doors; glass shelves. Makassar ebony veneer back panel and LED lighting. Metal handles.

Каркас из изогнутой фанеры, обтянутый кожей. Ножки из бука с металлическими деталями. Резные стеклянные дверцы, стеклянные полки. Задняя панель изготовлена из макаassarского эбенового дерева и светодиодная подсветка. Латунными ручками.

曲面胶合板结构，皮革覆盖。山毛榉柜角点缀金属装饰细节。雕花玻璃门，玻璃置物架。望加錫乌木背板，LED照明。金属把手。

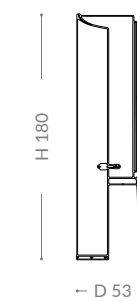
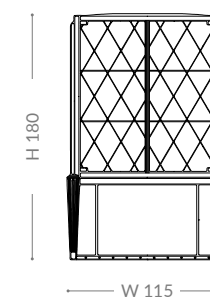
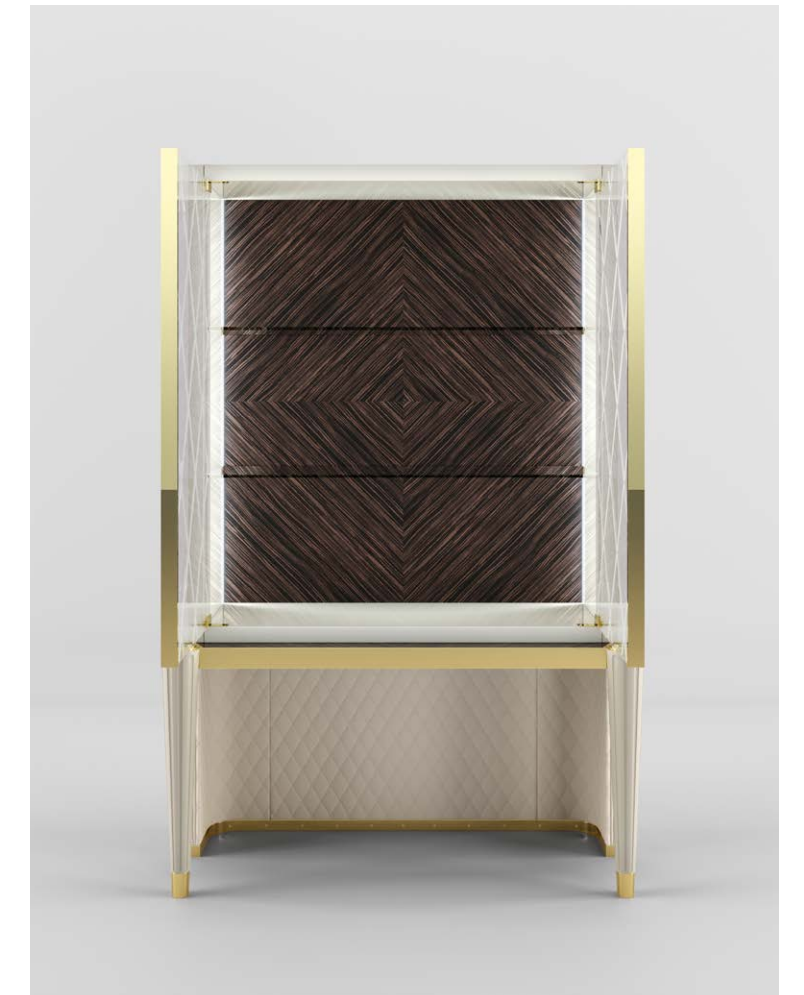

# VENUS

DISPLAY CABINET

Struttura in noce canaletto massello. Ripiani interni in vetro, schienale in pelle ricamata. Ante in vetro curvato e noce canaletto, maniglie in metallo satinato.

Solid canaletto walnut wood structure. Internally fitted with glass shelves, quilted leather back panel. Doors in curved glass and canaletto walnut wood. Satin metal handles.

Каркас из массива ореха каналетто. Внутри установлены стеклянные полки, задняя панель отделана стеганой кожей. Двери выполнены из гнутого стекла и древесины ореха каналетто. Ручки из сатинированного металла.

卡纳莱托胡桃木实木结构。内部配有玻璃陈列架，绗缝皮革背板。柜门采用曲面玻璃和卡纳莱托胡桃木。缎纹金属把手。



DISPLAY CABINETS

As picture: Venus display cabinet  
In price list: Prime

Lucidatura/Finishing/Отделка/饰面  
70. CANALETTO WALNUT MATT

Parti in metallo/Metal parts/Металлическая фурнитура/金属部件  
SATIN GOLD

Materiale/Material/Материал/材料  
BZ 906-2005 LEATHER OASI

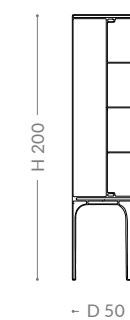
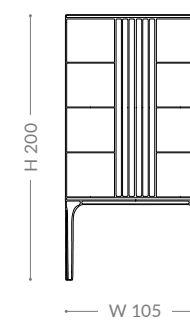





ZB

# BOOKSHELVES



# CLARK

BOOKSHELF

Struttura in legno massello, multistrati di legno e MDF. Schienale con decorazione in bassorilievo. Maniglie in ottone.

Solid wood, plywood and MDF structure. Back panel with low relief decoration. Brass handles.

Каркас из массива дерева, фанеры и МДФ. Задняя панель украшена барельефом. Латунные ручки.

实木、胶合板和中密度纤维板结构。背板采用浅浮雕装饰。黄铜把手。

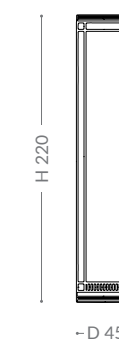
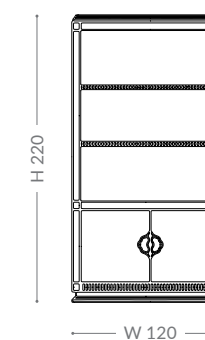

As picture: Clark bookshelf  
In price list: Brilliant

Lucidatura/Finishing/Отделка/饰面  
50. IVORY

Parti in metallo/Metal parts/Металлическая фурнитура/金属部件  
GOLD

# DAFNE

BOOKSHELF

Struttura in metallo satinato, multistrati di legno e MDF. Parte interna e ante decorate in pelle ricamata. Parte esterna e ripiani in legno laccato.

Satin metal, plywood and MDF structure. Quilted leather inner body and doors. Lacquered wooden outer structure and shelves.

Каркас из сатинированного металла, фанеры и МДФ. Внутренние поверхности и двери из стеганой кожи. Внешние поверхности и полки из лакированной древесины.

缎纹金属、胶合板和中密度纤维板结构。书架内部和书架门采用绗缝皮革。外部结构和陈列架采用漆木。

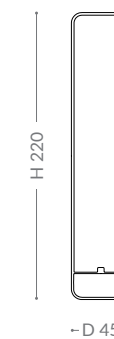
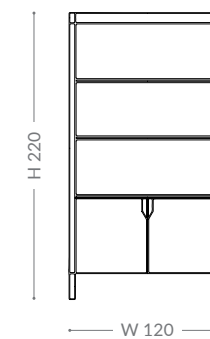
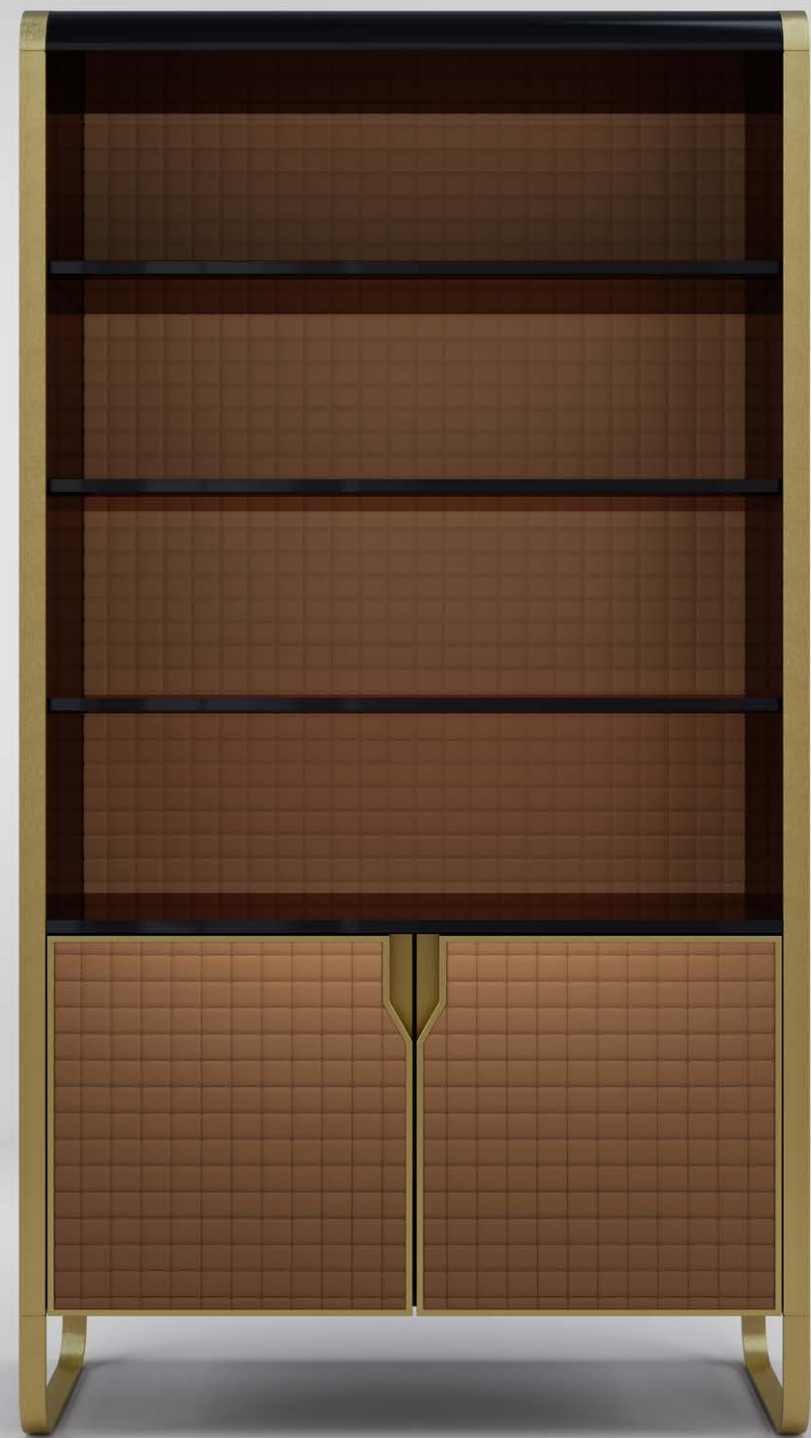

BOOKSHELVES

As picture: Dafne bookshelf  
In price list: Brilliant

Lucidatura/Finishing/Отделка/饰面  
57. CHOCOLATE

Parti in metallo/Metal parts/Металлическая фурнитура/金属部件  
SATIN GOLD

Materiale/Material/Материал/材料  
BZ 905-5103 LEATHER LOBSTER

# JADE

BOOKSHELF

BOOKSHELVES



Struttura in legno massello, multistrati di legno e MDF. Parte posteriore decorata in pelle ricamata. Ripiani con dettagli in metallo.

Solid wood, plywood and MDF structure. Quilted leather back panel. Shelves with metal details.

Каркас из массива дерева, фанеры и МДФ. Задняя панель отделана стеганой кожей. Полки с металлическими деталями.

实木、胶合板和中密度纤维板结构。绗缝皮革背板。陈列架带有金属配饰。

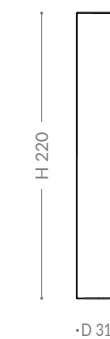
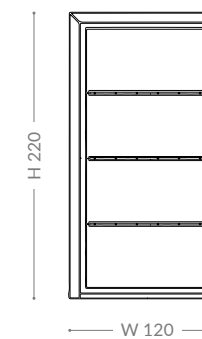

As picture: Jade bookshelf  
In price list: Brilliant

Lucidatura/Finishing/Отделка/饰面  
57. CHOCOLATE

Parti in metallo/Metal parts/Металлическая фурнитура/金属部件  
GOLD

Materiale/Material/Материал/材料  
BZ 905-5072 LEATHER CHAMPAGNE

# SIRIO

BOOKSHELF



Struttura in legno massello, multistrati di legno e MDF. Cornice perimetrale disponibile in essenza di eucalipto, noce canaletto o ebano makassar. Parte interna in legno laccato con profili in metallo. Schienale interno in alcantara. Decorazione centrale in vetro retroverniciato e logo Bruno Zampa.

Solid wood, plywood and MDF structure. Frame available in eucalyptus, canaletto walnut or makassar ebony veneer. Lacquered wooden inner structure, with metal profiles. Alcantara back panel. Back-painted glass central decoration, with Bruno Zampa logo.

Каркас из массива дерева, фанеры и МДФ. Доступные материалы рамы: шпон эвкалипта, ореха каналетто или макаassarского эбена. Внутренний каркас из лакированной древесины с металлическим профилем. Задняя панель отделана алькантарой. Декоративный элемент в центре из окрашенного с тыльной стороны стекла с логотипом Bruno Zampa.

实木、胶合板和中密度纤维板结构。框架可选用桉木饰面、卡纳莱托胡桃木饰面或孟加锡乌木饰面。内部结构采用漆木，带有金属型材。阿尔坎塔拉人造皮背板。中部采用带有 Bruno Zampa 品牌标志的背面彩绘玻璃装饰。

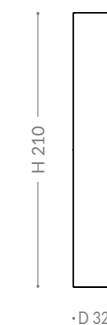
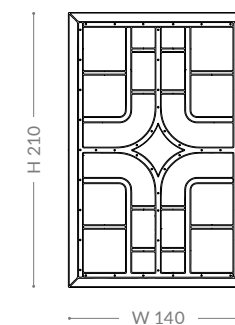

As picture: Sirio bookshelf  
In price list: Brilliant

Lucidatura/Finishing/Отделка/饰面  
68. EUCALYPTUS FRISÉ  
101. COFFEE MATT

Vetro/Glass/  
Стеклоное изделие/玻璃  
51. SAND

Parti in metallo/Metal parts/Металлическая фурнитура/金属部件  
TITANIUM  
Materiale/Material/Материал/材料  
BZ 186-077 IVORY



# CONCORDE

WARDROBE CABINET



Struttura in legno massello e multistrati di legno. Disponibile in essenza di noce canaletto o ebano makassar. Dettagli e maniglie in metallo. Parte interna suddivisa in appenderia con portaombrelli (schienale a specchio e luce a LED), portascarpe estraibili, cassetto portaogetti e portaborse.

Solid wood and plywood structure. Available in canaletto walnut or makassar ebony veneer. Metal handles and details. Internally fitted with hanger rod and umbrella stand (LED lighting mirror back panel), pull-out shoe organizer, drawer and bags organizer.

Каркас из массива дерева и фанеры. Доступные материалы: шпон ореха каналетто или макаassarского эбена. Металлические ручки и детали. Внутри установлены штанга для одежды и подставка для зонтов (зеркальная задняя панель со светодиодной подсветкой), а также выдвижной органайзер для обуви, выдвижной ящик и органайзер для сумок.

实木和胶合板结构。可选用卡纳莱托胡桃木饰面或孟加锡乌木饰面。金属把手及配饰。内部配有吊杆和伞架（LED 照明镜面背板）、推拉式鞋架、抽屉以及收纳包。

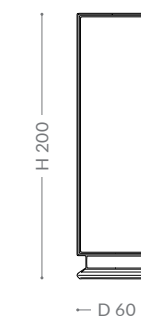
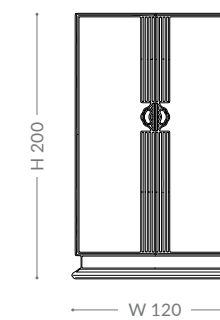

As picture: Concorde wardrobe cabinet  
In price list: Brilliant

Lucidatura/Finishing/Отделка/饰面  
64. CANALETTO WALNUT  
54. GREY

Parti in metallo/Metal parts/Металлическая фурнитура/金属部件  
TITANIUM

# CONCORDE

WINE CABINET



Struttura in legno massello e multistrati di legno. Disponibile in essenza di noce canaletto o ebano makassar. Dettagli e maniglie in metallo. Parte interna suddivisa in portabottiglie estraibili, cassetto per accessori, vano portabottiglie (schienale a specchio e luce a LED) e vani per oggetti decorativi.

Solid wood and plywood structure. Available in canaletto walnut or makassar ebony veneer. Metal handles and details. Internally fitted with pull-out bottle holder, accessories drawer, bottle compartment (LED lighting mirror back panel) and decorative objects compartments.

Каркас из массива дерева и фанеры. Доступные материалы: шпон ореха канаletto или макассарского эбена. Металлические ручки и детали. Внутри оборудованы выдвижная полка для бутылок, ящик для принадлежностей, отделение для бутылок (зеркальная задняя панель со светодиодной подсветкой) и отделение для предметов декора.

实木和胶合板结构。可选用卡纳莱托胡桃木饰面和或孟加锡乌木饰面。金属把手及配饰。内部配有推拉式瓶架、收纳抽屉、瓶罐收纳架（LED 照明镜面背板）、以及装饰物品摆放架。

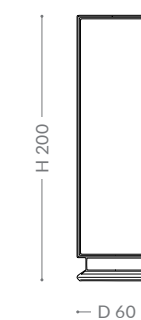
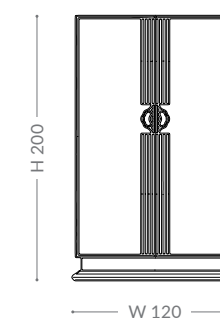
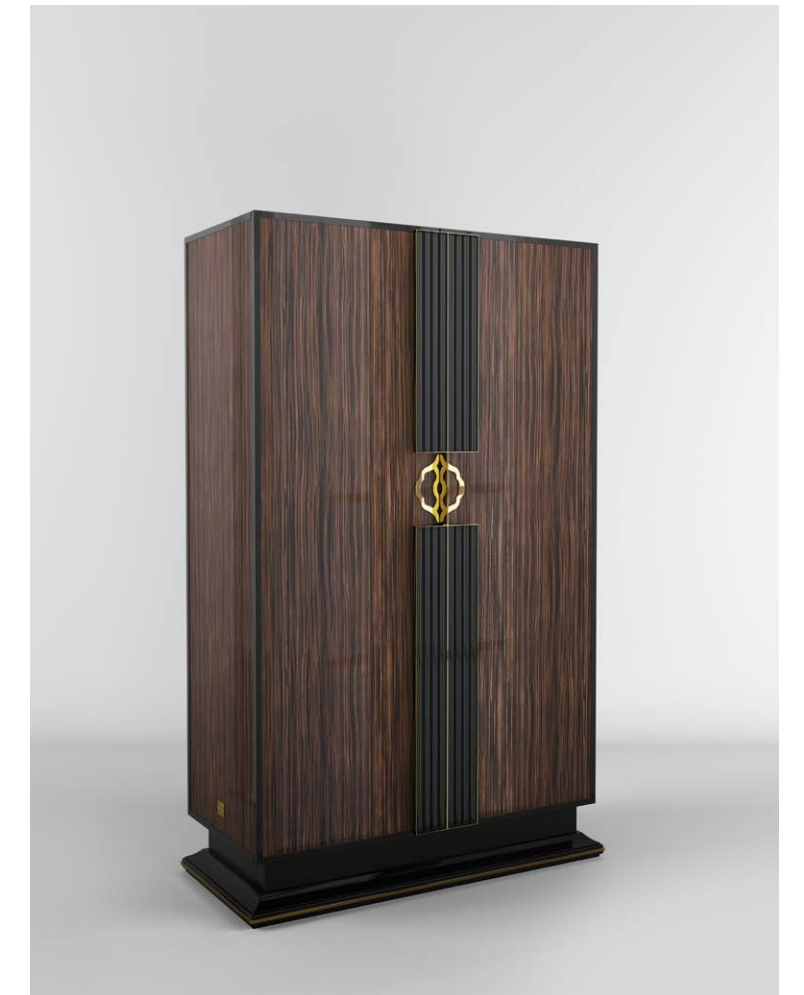

As picture: Concorde wine cabinet  
In price list: Brilliant

Lucidatura/Finishing/Отделка/饰面  
65. MAKASSAR  
57. CHOCOLATE

Parti in metallo/Metal parts/Металлическая фурнитура/金属部件  
GOLD



# DEDALO

MODULAR SYSTEM

Sistema modulare di elementi per comporre mobili adatti ai più svariati ambienti e concept d'arredo. Di seguito presentiamo alcuni esempi delle infinite possibilità di composizione.

## DESCRIZIONE TECNICA

Struttura in legno massello e multistrati di legno. Parte esterna disponibile in legno laccato o essenza di noce canaletto. Parte interna disponibile in legno laccato. Schienale rivestito in alcantara ricamata. Ripiani in cristallo color bronzo. Ante in legno decorate in pelle ricamata o in vetro color bronzo. Sono disponibili distanziali e base d'appoggio per la composizione dei vari sistemi modulari.

Modular system to combine furniture elements for different rooms and concepts. Some examples of the many combination possibilities are presented.

## TECHNICAL DESCRIPTION

Solid wood and plywood structure. Outer structure available in lacquered wood or canaletto walnut veneer. Lacquered wood inner structure. Quilted alcantara back panel. Crystal shelves, bronze colour. Spacers and support base for the compositions are available.

Модульная система, которая комплектуется из элементов мебели для разных типов помещений и концепций. Предлагаем вашему вниманию несколько примеров из множества возможных комбинаций.

## ТЕХНИЧЕСКОЕ ОПИСАНИЕ

Каркас из массива дерева и фанеры. Доступные материалы внешнего каркаса: лакированная древесина или шпон ореха канаletto. Лакированный внутренний каркас. Задняя панель отделана стеганой алькантарой. Хрустальной полкой, бронзового цвета. Имеются разделители и опорные элементы для составления композиций.

采用模块化系统，组合家具元素，以契合不同的房间和理念。许多可能组合的若干示例给出如下。

## 技术说明

实木和胶合板结构。外部结构可选用漆木或卡纳莱托胡桃木饰面，内部为喷漆结构。绗缝阿尔坎塔拉人造皮背板。水晶陈列架，青铜色。可选用组合垫片和支撑底座。

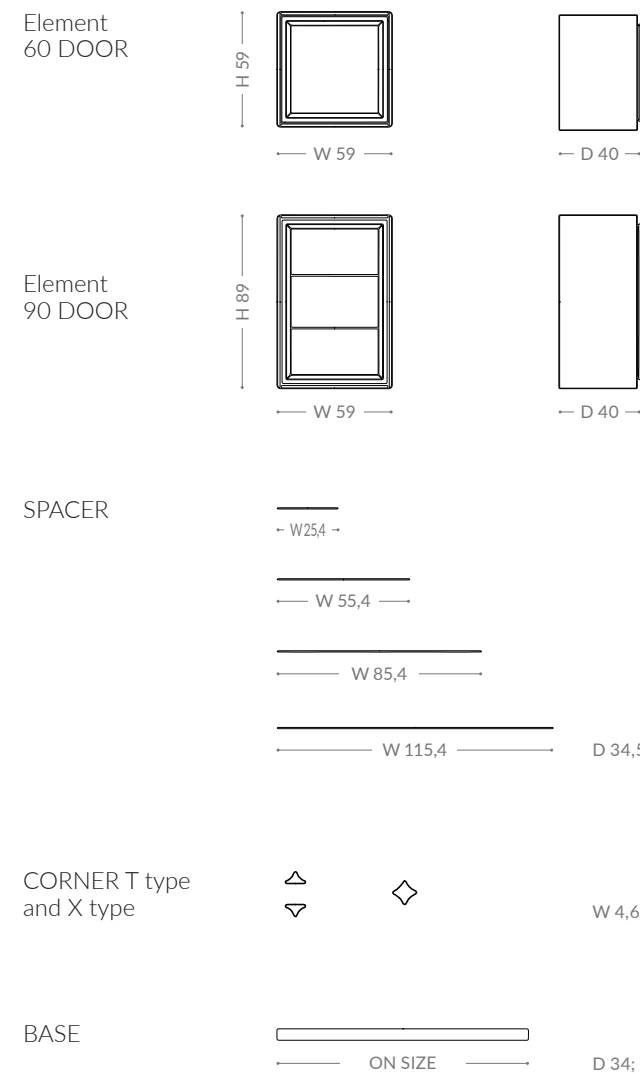
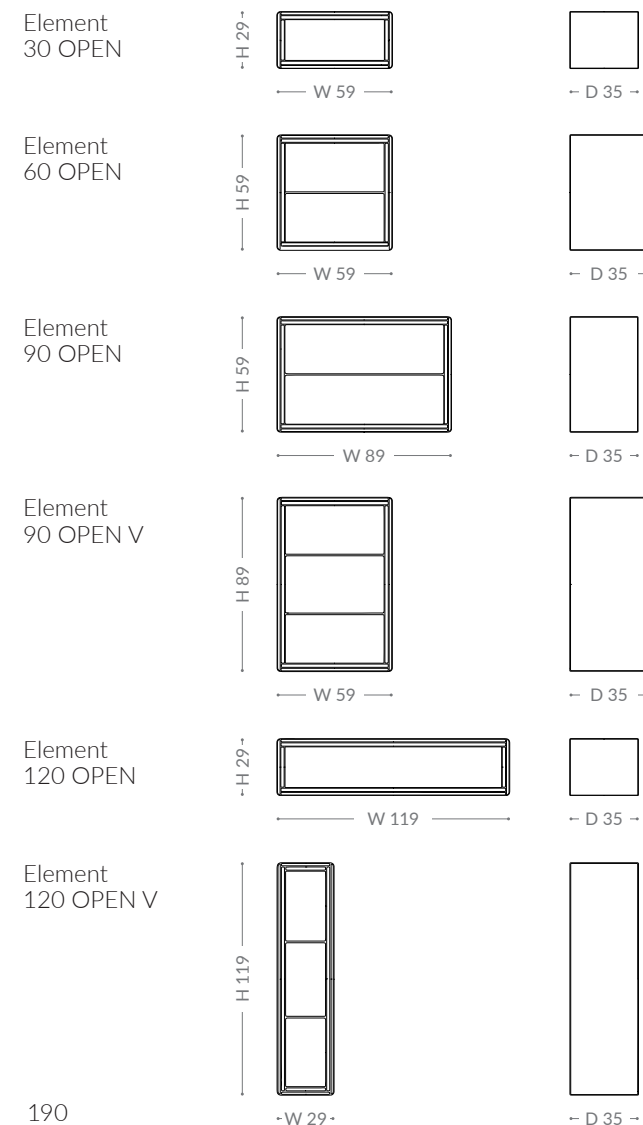

# DEDALO

BACK SOFA CABINET



As picture: Dedalo back sofa cabinet  
In price list: Prime

Lucidatura/Finishing/Отделка/饰面  
70. CANALETTO WALNUT MATT  
81. SAND MATT  
85. CHOCOLATE MATT

Materiale/Material/Материал/材料  
BZ 905-5234 LEATHER BEIGE

Vetro/Glass/Стекло  
изделие/玻璃  
BRONZE

# DEDALO

CABINET

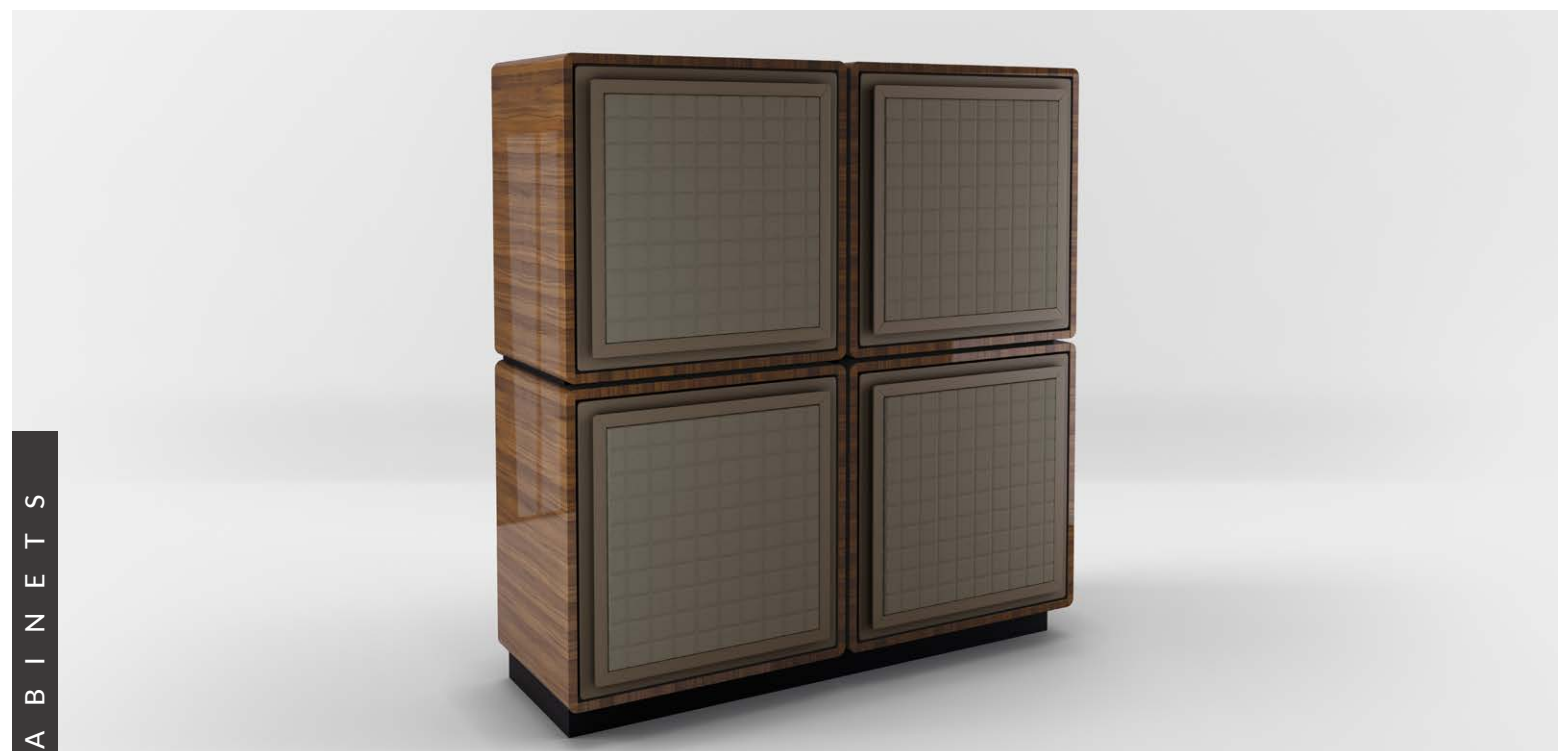

C A B I N E T S

**As picture: Dedalo cabinet**  
In price list: Brilliant

Lucidatura/Finishing/Отделка/饰面  
69. CANALETTO WALNUT  
89. TAUPE MATT  
85. CHOCOLATE MATT

Materiale/Material/Материал/材料  
BZ 906-2007 LEATHER MOKA

Vetro/Glass/Стекло  
изделие/玻璃  
BRONZE

# DEDALO

DUAL UNIT



**As picture: Dedalo dual unit**  
In price list: Brilliant

Lucidatura/Finishing/Отделка/饰面  
69. CANALETTO WALNUT  
100. GREY MATT  
92. TIFFANY MATT

Parti in metallo/Metal parts/Металлическая фурнитура/金属部件  
SATIN TITANIUM

C A B I N E T S

# DEDALO

FREE STANDING PARTITION 1



C A B I N E T S

**As picture: Dedalo  
free standing partition 1**  
In price list: Prime

Lucidatura/Finishing/Отделка/饰面  
70. CANALETTO WALNUT MATT  
81. SAND MATT  
85. CHOCOLATE MATT

Vetro/Glass/Стекло  
изделие/玻璃  
BRONZE

# DEDALO

FREE STANDING PARTITION 2



C A B I N E T S

**As picture: Dedalo  
free standing partition 2**  
In price list: Prime

Lucidatura/Finishing/Отделка/饰面  
93. WENGÉ MATT  
100. GREY MATT  
85. CHOCOLATE MATT

Vetro/Glass/Стекло  
изделие/玻璃  
BRONZE

# DEDALO

LIBRARY

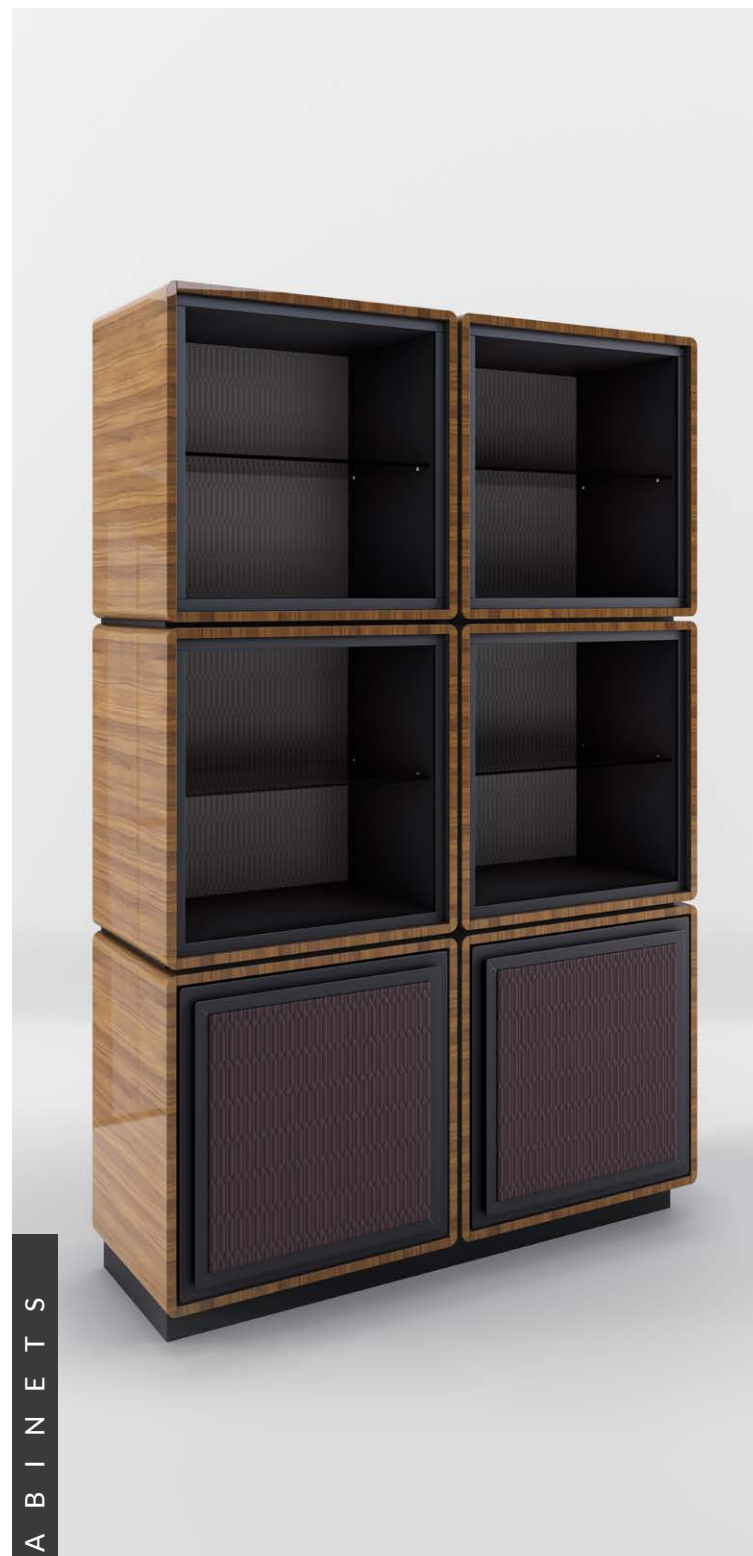

C A B I N E T S

**As picture: Dedalo library**  
In price list: Brilliant

Lucidatura/Finishing/Отделка/饰面  
69. CANALETTO WALNUT  
85. CHOCOLATE MATT

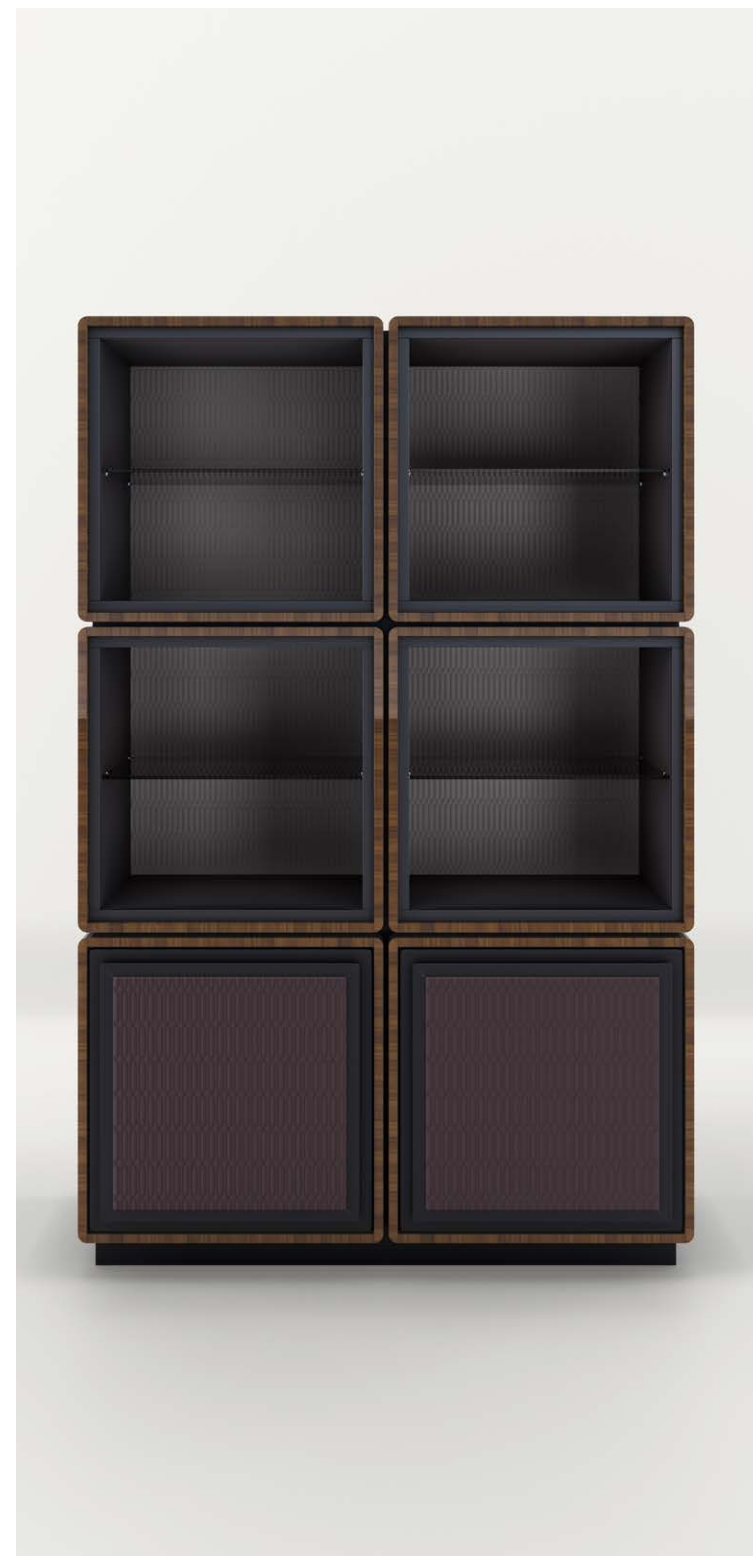

Materiale/Material/Материал/材料  
BZ 906-2003 LEATHER DARK BROWN

Vetro/Glass/Стекло  
изделие/玻璃  
BRONZE

# DEDALO

OFFICE COMPOSITION



C A B I N E T S

**As picture: Dedalo office composition**  
In price list: Brilliant

Lucidatura/Finishing/Отделка/饰面  
57. CHOCOLATE  
84. LOBSTER MATT  
85. CHOCOLATE MATT

Materiale/Material/Материал/材料  
BZ 905-5103 LEATHER LOBSTER

Vetro/Glass/Стекло  
изделие/玻璃  
BRONZE

# DEDALO

SIDEBOARD



**As picture: Dedalo sideboard**  
In price list: Brilliant

Lucidatura/Finishing/Отделка/饰面  
69. CANALETTO WALNUT  
100. GREY MATT  
85. CHOCOLATE MATT

Vetro/Glass/Стеклоное  
изделие/玻璃  
BRONZE

# DEDALO

TV CABINET 1



**As picture: Dedalo TV cabinet 1**  
In price list: Brilliant

Lucidatura/Finishing/Отделка/饰面  
98. WENGÉ  
90. CARAMEL MATT  
85. CHOCOLATE MATT

# DEDALO

TV COMPOSITION 1



C A B I N E T S

**As picture: Dedalo TV composition 1**  
In price list: Prime

Lucidatura/Finishing/Отделка/饰面  
70. CANALETTO WALNUT MATT  
91. BURGUNDY MATT  
85. CHOCOLATE MATT

Materiale/Material/Материал/材料  
BZ 906-2030 LEATHER BURGUNDY

Vetro/Glass/Стекло  
изделие/玻璃  
BRONZE

# DEDALO

TV COMPOSITION 2



C A B I N E T S

**As picture: Dedalo TV composition 2**  
In price list: Prime

Lucidatura/Finishing/Отделка/饰面  
70. CANALETTO WALNUT MATT  
81. SAND MATT  
85. CHOCOLATE MATT

Materiale/Material/Материал/材料  
BZ 905-5234 LEATHER BEIGE

Vetro/Glass/Стекло  
изделие/玻璃  
BRONZE

# DEDALO

TV COMPOSITION 3



C A B I N E T S

**As picture: Dedalo TV composition 3**  
In price list: Prime

Lucidatura/Finishing/Отделка/饰面  
70. CANALETTO WALNUT MATT  
92. TIFFANY MATT  
85. CHOCOLATE MATT

Vetro/Glass/Стекло  
изделие/玻璃  
BRONZE

# DEDALO

WALL COMPOSITION



C A B I N E T S

**As picture: Dedalo wall composition**  
In price list: Prime

Lucidatura/Finishing/Отделка/饰面  
93. WENGÉ MATT  
100. GREY MATT  
85. CHOCOLATE MATT

Materiale/Material/Материал/材料  
BZ 906-2006 LEATHER TAUPE

Vetro/Glass/Стекло  
изделие/玻璃  
BRONZE

# FRITZ

BAR CABINET



As picture: Fritz bar cabinet  
In price list: Brilliant

Lucidatura/Finishing/Отделка/饰面  
53. DOVE GREY

Parti in metallo/Metal parts/Металлическая фурнитура/金属部件  
TITANIUM

Struttura in legno massello; gambe in legno intagliate a mano. Parte interna con ripiani in vetro e cassetti portaoggetti (schienale in specchio bronzo). Ante in legno laccato con maniglie in ottone.

Solid wood structure; Hand-carved wooden legs. Internally fitted with glass shelves and drawers (bronze mirror back panel). Lacquered wooden doors with brass handles.

Каркас из массива дерева, резные ножки ручной работы. Внутри установлены стеклянные полки и выдвижные ящики (зеркальная задняя панель бронзового оттенка). Двери из лакированной древесины с латунными ручками.

实木结构；木制柜脚采用手工雕刻。内部配有玻璃陈列架和抽屉（铜镜背板）。漆木柜门带有黄铜把手。

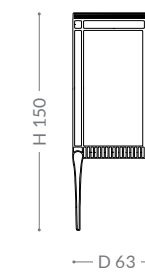
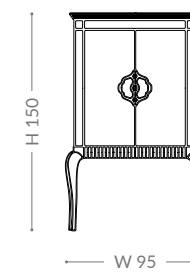



# RICHELIEU

BAR CABINET



Stuttura in metallo, legno massello e multistrati di legno. Piano disponibile in essenza di ebano makassar o eucalipto frisé. Parte esterna decorata in pelle ricamata. Gambe perimetrali in legno di faggio e dettagli in ottone. Parte interna allestita con 2 cassetti portaoggetti, 2 ripiani in vetro; schienale a specchio.

Metal, solid wood and plywood structure. Top available in makassar ebony or eucalyptus frisé veneer. Quilted leather outer body. Beechwood legs with brass details. Internally fitted with 2 drawers, 2 glass shelves; mirror back panel.

Каркас из металла, массива дерева и фанеры. Доступные материалы верхнего каркаса: шпон макассарского эбена или эвкалипта фризе. Выполнена наружная отделка стеганой кожей. Ножки из бука с латунными деталями. Внутри установлены 2 выдвижных ящика, 2 стеклянные полки и зеркальная задняя панель.

金属、实木及胶合板结构。台面可选用孟加锡乌木饰面或桉木饰面。外部为衍缝皮革。山毛榉柜脚带有黄铜配饰。内部配有 2 个抽屉，2 个玻璃陈列架；镜面背板。

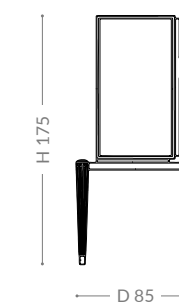
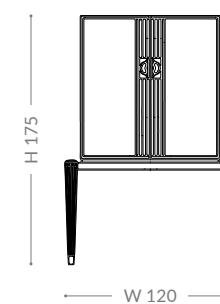

As picture: Richelieu bar cabinet  
In price list: Brilliant

Lucidatura/Finishing/Отделка/饰面  
68. EUCALYPTUS FRISÉ  
55. COFFEE

Parti in metallo/Metal parts/Металлическая фурнитура/金属部件  
TITANIUM

Materiale/Material/Материал/材料  
BZ 902-N8409 NABUK LIGHT BROWN

# RICHELIEU

GAMING CABINET



Stuttura in metallo, legno massello e multistrati di legno. Piano disponibile in essenza di ebano makassar o eucalip-  
to frisé. Parte esterna decorata in pelle  
ricamata. Gambe perimetrali in legno di  
faggio e dettagli in ottone. Parte interna  
rivestita in alcantara e pelle, allestita  
con roulette da tavolo con accessori,  
2 cassette portagiochi, vano bottiglie  
alcolici e umidificatore sigari.

Metal, solid wood and plywood  
structure. Top available in makas-  
sar ebony or eucalyptus frisé ve-  
neer. Quilted leather outer body.  
Beechwood legs with brass  
details. Alcantara and leather  
padded internals, fitted with  
roulette and accessories, drawers  
for card games accessories, bottle  
compartment, cigar humidifier.

Каркас из металла, массива дерева и фане-  
ры. Доступные материалы верхнего каркаса:  
шпон макассарского эбена или эвкалипта  
фризе. Выполнена наружная отделка  
стеганой кожей. Ножки из бука с латунными  
детальями. Выполнена внутренняя отделка  
алькантарой и кожей, установлены рулетка  
с аксессуарами, выдвижные ящики для  
принадлежностей к карточным играм, отде-  
ление для бутылок и увлажнитель сигар.

金属、实木及胶合板结构。台  
面可选用孟加锡乌木饰面或桉  
木饰面。外部为衍缝皮革。  
山毛榉柜脚带有黄铜配饰。内  
部采用阿尔坎塔拉人造皮和皮  
革衬垫，配有轮盘赌及配件、  
卡牌游戏配件抽屉、瓶罐收纳  
架、雪茄加湿器。

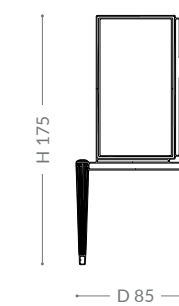
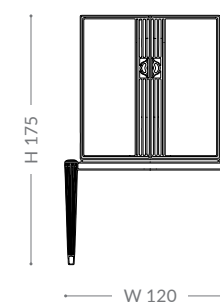

As picture: Richelieu  
gaming cabinet  
In price list: Brilliant

Lucidatura/Finishing/Отделка/饰面  
65. MAKASSAR  
57. CHOCOLATE

Parti in metallo/Metal parts/Метал-  
лическая фурнитура/金属部件  
GOLD

Materiale/Material/Материал/材料  
BZ 901-332 LEATHER BUTTER

# VENUS

CABINET



Struttura in noce canaletto massello. Ripiani interni in vetro, schienale a specchio. Ante in noce canaletto curvato e maniglie in metallo satinato.

Canaletto walnut solid wooden structure. Glass shelves and mirror back panel. Curved canaletto walnut wooden doors and satin metal handles.

Каркас из массива ореха каналетто. Стекло-зеркальная задняя панель. Двери из изогнутой древесины ореха каналетто с ручками из сатинированного металла.

卡纳莱托胡桃木实木结构。玻璃陈列架和镜面背板。曲面卡纳莱托胡桃木门和缎纹金属把手。

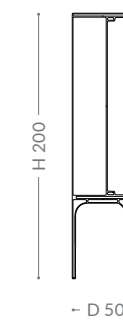
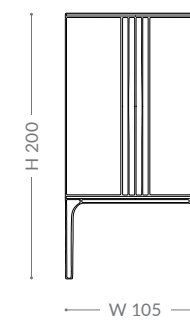

CABINETS

As picture: Venus cabinet  
In price list: Brilliant

Lucidatura/Finishing/Отделка/饰面  
69. CANALETTO WALNUT

Parti in metallo/Metal parts/Металлическая фурнитура/金属部件  
SATIN GOLD



ZB

## DESKS



# ASTORIA

DESK



Struttura in legno massello, multistrati curvato e MDF. Piano disponibile in essenza di ebano makassar. Top e parti esterne decorati in pelle ricamata. Profili e dettagli in metallo. Passacavi in metallo multifunzione. Sottomano in pelle disponibile su richiesta.

Solid wood frame, curved plywood and MDF. Top available in makassar ebony veneer. Quilted leather decorated top and outer body. Metal details and profiles. Multifunctional metal cable organizer. Leather desk pad on request.

Рама из массива дерева, изогнутой фанеры и МДФ. Столешница из шпона макассарского эбена. Отделка столешницы и внешней части каркаса стеганой кожей. Металлические детали и профили. Многофункциональная металлическая заглушка для кабеля. Кожаная настольная подкладка можно приобрести по запросу.

实木框架，曲面胶合板和中密度纤维板。桌面为孟加锡乌木饰面。桌面和外部框架采用绗缝皮革装饰。金属配饰和侧面轮廓。多功能金属理线器。可应要求提供皮革书桌垫。

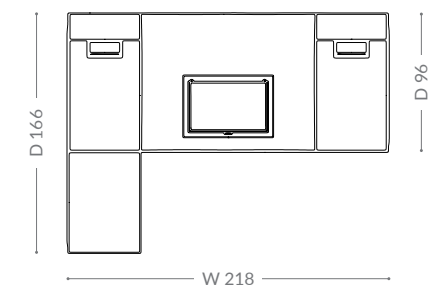
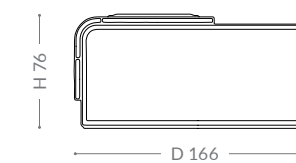
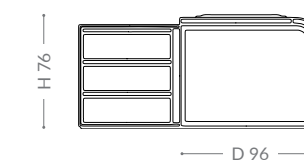
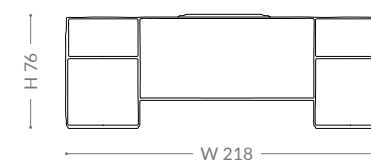

D E S K S

**As picture: Astoria desk**  
In price list: Brilliant/Leather  
desk pad on request.

Lucidatura/Finishing/Отделка/饰面  
65. MAKASSAR  
57. CHOCOLATE

Parti in metallo/Metal parts/Метал-  
лическая фурнитура/金属部件  
GOLD

Materiale/Material/Материал/材料  
BZ 905-5103 LEATHER LOBSTER

# CLARK

DESK

Struttura in legno massello, multistrati di legno e MDF. Decorazione frontale in metallo. Disponibile con uno o due passacavi. Sottomano rivestito in pelle.

Solid wood, plywood and MDF frame. Metal frontal decoration. Available with one or two cable organizers. Leather desk pad.

Рама из массива дерева, фанеры и МДФ. Фронтальная металлическая отделка. Доступен с одной или двумя заглушками для кабеля. Кожаная настольная подкладка.

实木、胶合板、以及中密度纤维板 (MDF) 框架。正面采用金属装饰。可装配一个或两个理线器。包含皮革书桌垫。

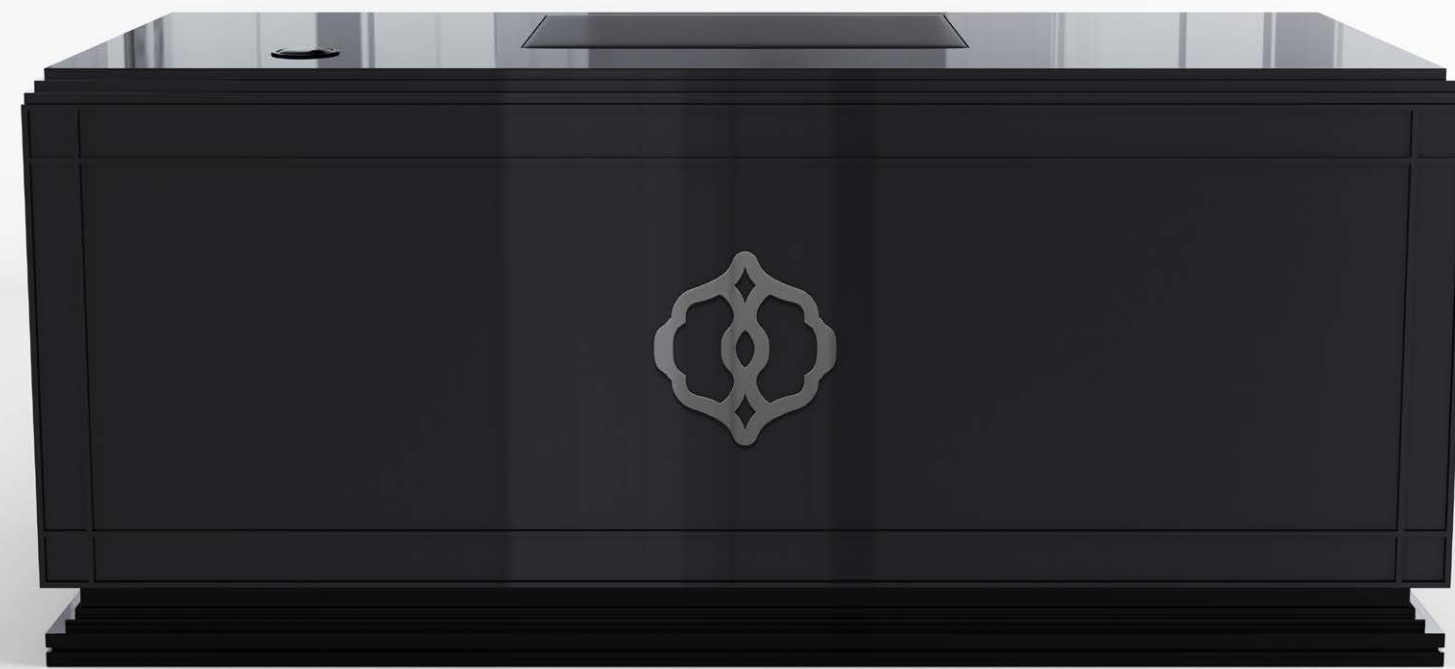

DESKS

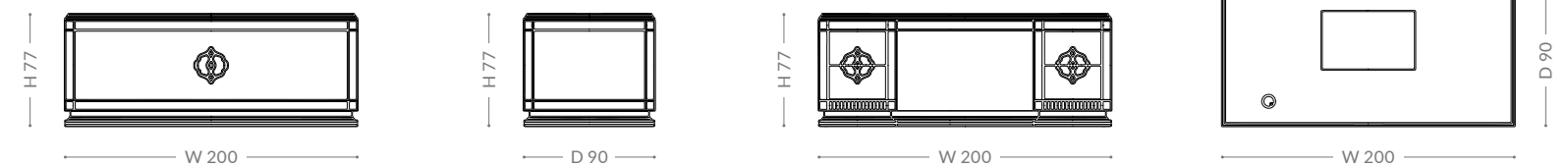

As picture: Clark desk  
In price list: Brilliant

Lucidatura/Finishing/Отделка/饰面  
57. CHOCOLATE

Parti in metallo/Metal parts/Металлическая фурнитура/金属部件  
TITANIUM

Materiale/Material/Материал/材料  
BZ 901-965 LEATHER BLACK

# LEGEND

DESK

Struttura in legno massello, multistrati di legno e MDF. Piano in legno laccato. Decorazione parte esterna e cassetti in pelle ricamata con dettagli in metallo. Colonne decorative in legno e ottone. Disponibile con uno o due passacavi. Sottomano in pelle disponibile su richiesta.

Solid wood, plywood and MDF frame. Lacquered wooden top. Quilted leather outer body and drawers, with metal details. Wooden and brass legs. Available with one or two cable organizers. Leather desk pad on request.

Рама из массива дерева, фанеры и МДФ. Столешница из лакированной древесины. Внешняя часть каркаса и выдвижные ящики с отделкой стеганой кожей, металлические детали. Ножки из дерева и латуни. Доступен с одной или двумя заглушками для кабеля. Кожаная настольная подкладка можно приобрести по запросу.

实木、胶合板、以及中密度纤维板 (MDF) 框架。漆木桌面。外部框架和抽屉采用绗缝皮革，带有精细金属配饰。木制黄铜桌腿。可装配一个或两个理线器。可应要求提供皮革书桌垫。

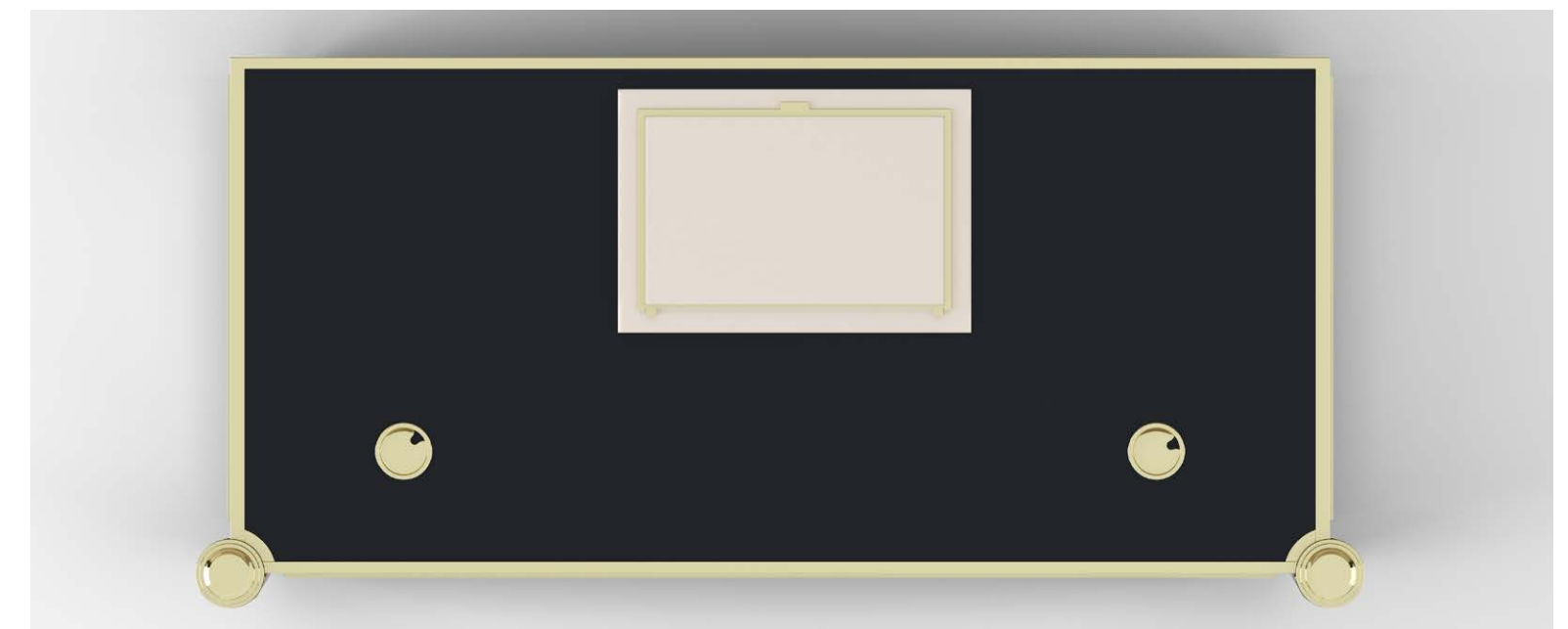
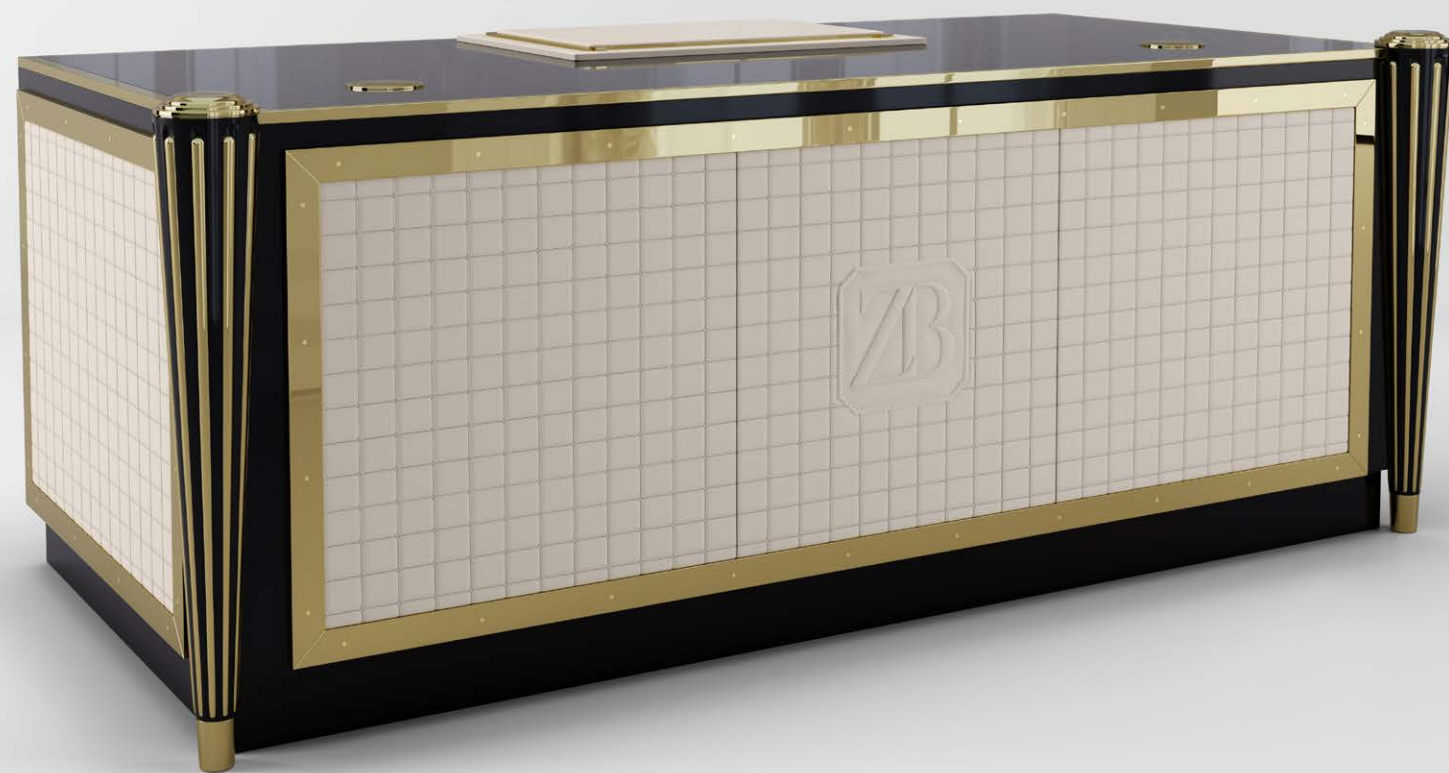

DESKS

**As picture: Legend desk**  
In price list: Brilliant/Leather desk pad on request.

Lucidatura/Finishing/Отделка/饰面  
57. CHOCOLATE

Parti in metallo/Metal parts/Металлическая фурнитура/金属部件  
GOLD

Materiale/Material/Материал/材料  
BZ 901-891 LEATHER IVORY

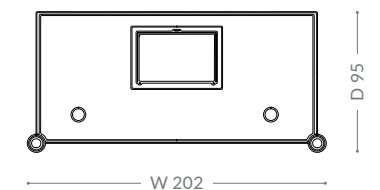
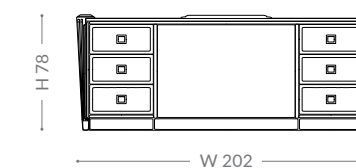
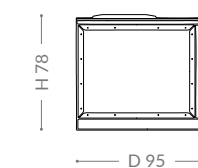
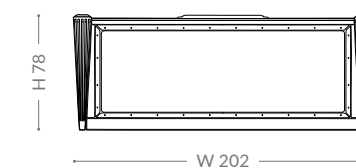

# SQUARE

DESK



Struttura in legno massello, multistrati di legno e metallo martellato. Piano scrivania in essenza di noce canaletto. Disponibile con uno o due passacavi. Sottomano in pelle disponibile su richiesta.

Solid wood frame, plywood and hammered metal. Canaletto walnut veneer top. Available with one or two cable organizers. Leather desk pad on request.

Рама из массива дерева, фанеры и кованого металла. Столешница из шпона ореха каналетто. Доступен с одной или двумя заглушками для кабеля. Кожа на настольная подкладка можно приобрести по запросу.

实木框架，胶合板和锤纹金属。桌面采用卡纳莱托胡桃木饰面。可装配一个或两个理线器。可应要求提供皮革书桌垫。

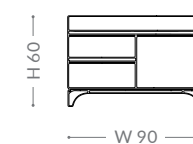
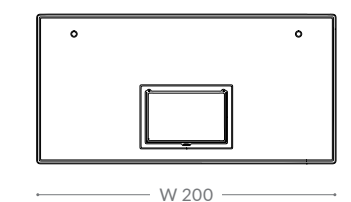
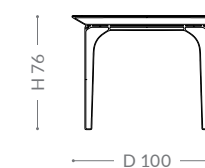
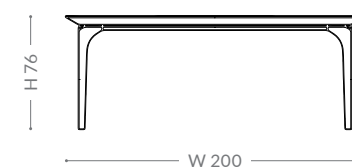

DESKS

**As picture: Square desk + return desk**  
In price list: Prime/Leather desk pad on request.

Scrivania/Desk/Стол/书桌  
89. TAUPE MATT  
70. CANALETTO WALNUT MATT

Parti in metallo/Metal parts/Металлическая фурнитура/金属部件  
HAMMERED GOLD  
Materiale/Material/Материал/材料  
BZ 906-2007 LEATHER MOKA

Cassettiera/Return desk/Тумба/  
小五斗柜  
89. TAUPE MATT  
70. CANALETTO WALNUT MATT





ZB

## OFFICE CHAIRS



# ATLANTIS

OFFICE CHAIR



OFFICE CHAIRS

**As picture: Atlantis office chair**  
In price list: Ambition/Brilliant



Materiale/Material/Материал/材料  
BZ 901-891 LEATHER IVORY

Lucidatura/Finishing/Отделка/饰面  
53. DOVE GREY

Struttura in legno massello e multistrati di legno. Guscio in pelle ricamata. Parte interna decorata con lavorazione capitonné. Imbottiture in poliuretano espanso a quote differenziate. Base a 5 razze in metallo e legno laccato con ruote "Design", regolabile in altezza.

Solid wood and plywood frame. Quilted leather shell. Capitoné inner body. Multiple densities polyurethane foam padding. 5 feet metal base and lacquered wood with "Design" wheels, adjustable height.

Рама из массива дерева и фанеры. Обшивка стеганой кожей. Внутренняя часть каркаса с отделкой в виде каретной стяжки. Набивка из пенополиуретана разной плотности. Основа из металла и лакированной древесины, с 5 роликами Design, регулируемая высота.

实木胶合板框架。外壳采用绗缝皮革。内部饱满。多重密度聚氨酯泡沫填充垫料。5 英尺金属底座（以及漆木）配有“专属设计”车轮，高度可调。

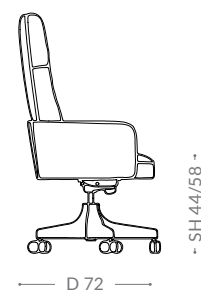
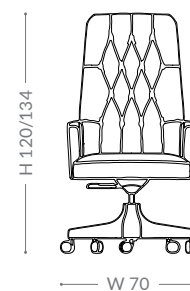

# COMET

FRONT DESK CHAIR



**As picture: Comet front desk chair**  
In price list: Ambition/Brilliant

Materiale/Material/Материал/材料  
BZ 905-5103 LEATHER LOBSTER

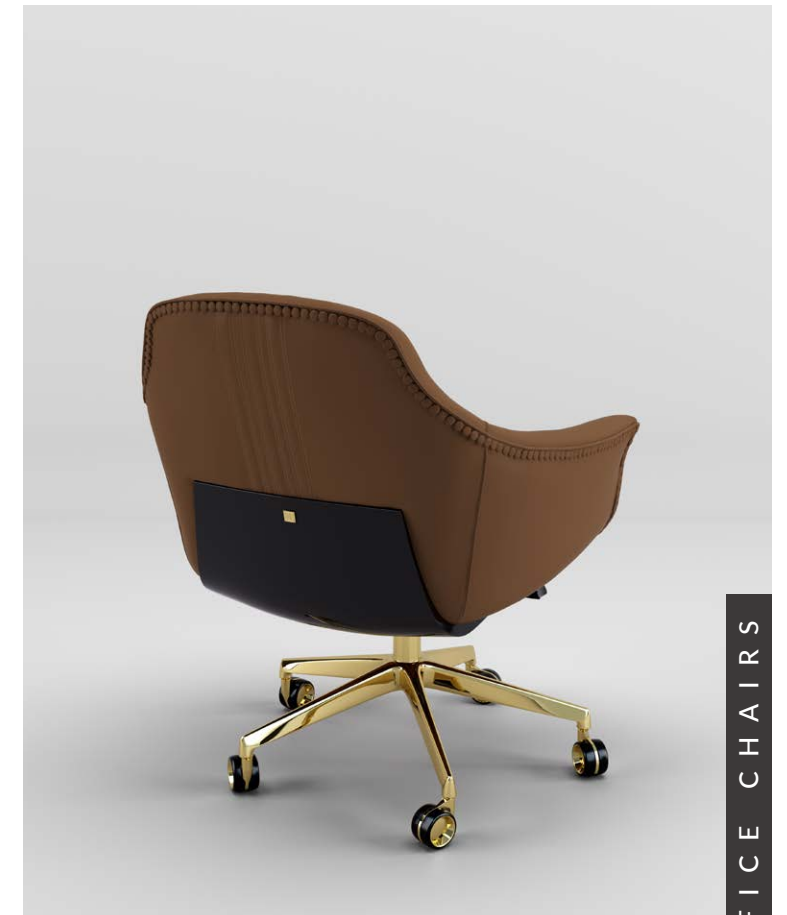

Lucidatura/Finishing/Отделка/饰面  
57. CHOCOLATE

Parti in metallo/Metal parts/  
Металлическая фурнитура/  
金属部件  
GOLD

OFFICE CHAIRS

Struttura in legno massello. Schienale e parte esterna in pelle ricamata. Decorazione con bottoni rivestiti in pelle. Imbottiture in poliuretano a quote differenziate. Guscio esterno in legno laccato. Base a 5 razze in metallo con ruote "Design", regolabile in altezza.

Solid wood frame. Quilted leather backrest and outer body. Finished with leather covered nails. Multiple densities polyurethane foam padding. Lacquered wooden shell. 5 feet metal base with "Design" wheels, adjustable height.

Рама из массива дерева. Спинка и внешняя часть каркаса с отделкой стеганой кожей. Стержни, обтянутые кожей. Набивка из пенополиуретана разной плотности. Обшивка из лакированной древесины. Металлическая основа с 5 роликами Design, регулируемая высота.

实木框架。靠背和外部框架采用绗缝皮革。采用包裹皮革的铆钉装饰固定。多重密度聚氨酯泡沫填充垫料。漆木外壳。5 英尺金属底座配有“专属设计”椅轮，高度可调。



# COMET

OFFICE CHAIR

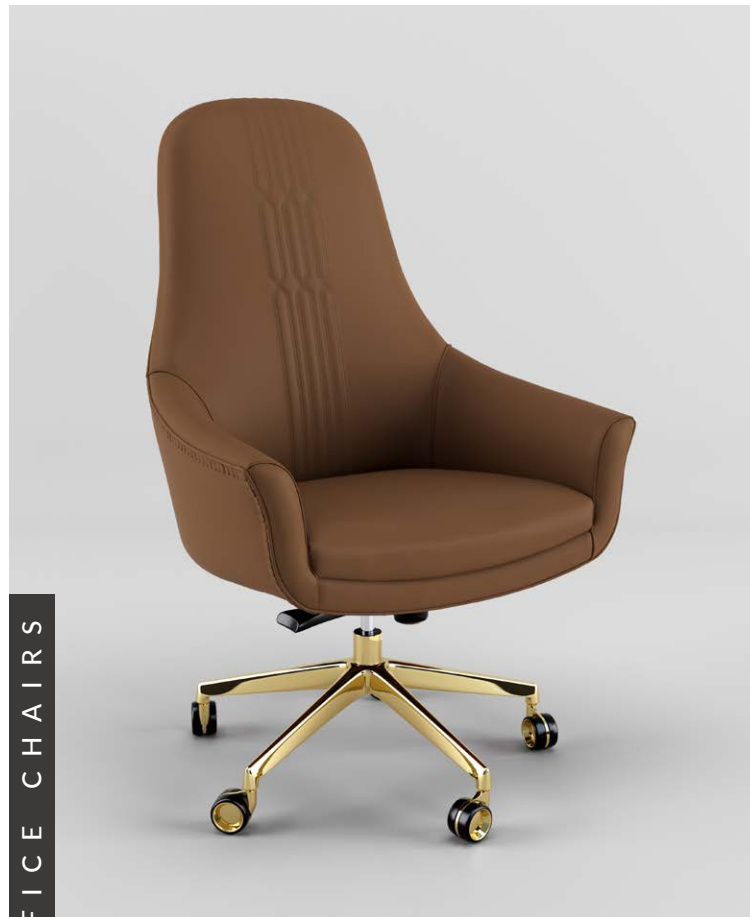

OFFICE CHAIRS

**As picture: Comet office chair**  
In price list: Ambition/  
Brilliant

Materiale/Material/Материал/材料  
BZ 905-5103 LEATHER LOBSTER



Lucidatura/Finishing/Отделка/饰面  
57. CHOCOLATE

Parti in metallo/Metal parts/Металлическая фурнитура/金属部件  
GOLD

Struttura in legno massello. Schienale e parte esterna in pelle ricamata. Decorazione con bottoni rivestiti in pelle. Imbottiture in poliuretano a quote differenziate. Guscio esterno in legno laccato. Base a 5 razze in metallo con ruote "Design", regolabile in altezza.

Solid wood frame. Quilted leather backrest and outer body. Finished with leather covered nails. Multiple densities polyurethane foam padding. Lacquered wooden shell. 5 feet metal base with "Design" wheels, adjustable height.

Рама из массива дерева. Спинка и внешняя часть каркаса с отделкой стеганой кожей. Стержни, обтянутые кожей. Набивка из пенополиуретана разной плотности. Обшивка из лакированной древесины. Металлическая основа с 5 роликами Design, регулируемая высота.

实木框架。靠背和外部框架采用绗缝皮革。采用包裹皮革的铆钉装饰固定。多重密度聚氨酯泡沫填充垫料。漆木外壳。5 英尺金属底座配有“专属设计”椅轮，高度可调。

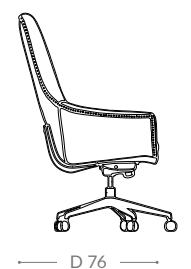
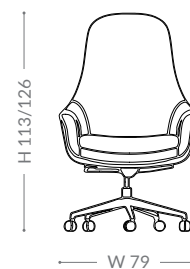

# LONDON

OFFICE CHAIR



**As picture: London office chair**  
In price list: Ambition

Materiale/Material/Материал/材料  
BZ 901-965 LEATHER BLACK



Parti in metallo/Metal parts/Металлическая фурнитура/金属部件  
CHROME

OFFICE CHAIRS

Struttura in legno massello e multistrati di legno. Imbottiture in poliuretano espanso a quote differenziate. Base a 5 razze in metallo con ruote "Design", regolabile in altezza.

Solid wood and plywood frame. Multiple densities polyurethane foam padding. 5 feet metal base with "Design" wheels, adjustable height.

Рама из массива дерева и фанеры. Набивка из пенополиуретана разной плотности. Металлическая основа с 5 роликами Design, регулируемая высота.

实木胶合板框架。多重密度聚氨酯泡沫填充垫料。5 英尺金属底座配有“专属设计”椅轮，高度可调。

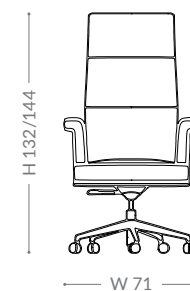

# REGENT

FRONT DESK CHAIR

OFFICE CHAIRS



**As picture: Regent front desk chair**  
In price list: Ambition

Materiale/Material/Mатериал/材料  
BZ 905-5141 LEATHER DARK GREY



Lucidatura/Finishing/Отделка/饰面  
70. CANALETTO WALNUT MATT

Parti in metallo/Metal parts/Металлическая фурнитура/金属部件  
SATIN GOLD - GOLD

Struttura in legno massello. Parte interna e braccioli in pelle ricamata. Parte esterna disponibile in essenza di noce canaletto. Telaio braccioli in metallo satinato. Imbottiture in poliuretano a quote differenziate. Base a 5 razze in metallo con ruote "Design", regolabile in altezza.

Solid wood frame. Quilted leather inner body and armrests. Canaletto walnut wooden veneer outer body. Satin metal armrests frame. Multiple densities polyurethane foam padding. 5 feet metal base with "Design" wheels, adjustable height.

Рама из массива дерева. Внутренняя часть каркаса и подлокотники из стеганой кожи. Внешняя часть каркаса из шпона ореха каналетто. Рама подлокотников из сатинового металла. Набивка из пенополиуретана разной плотности. Металлическая основа с 5 роликами Design, регулируемая высота.

实木框架。内部框架和扶手采用绗缝皮革。外部框架采用卡纳莱托胡桃木饰面。缎纹金属扶手框架。多重密度聚氨酯泡沫填充垫料。5英尺金属底座配有“专属设计”椅轮，高度可调。

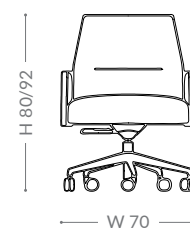

# REGENT

OFFICE CHAIR

OFFICE CHAIRS



**As picture: Regent office chair**  
In price list: Ambition

Materiale/Material/Mатериал/材料  
BZ 905-5141 LEATHER DARK GREY

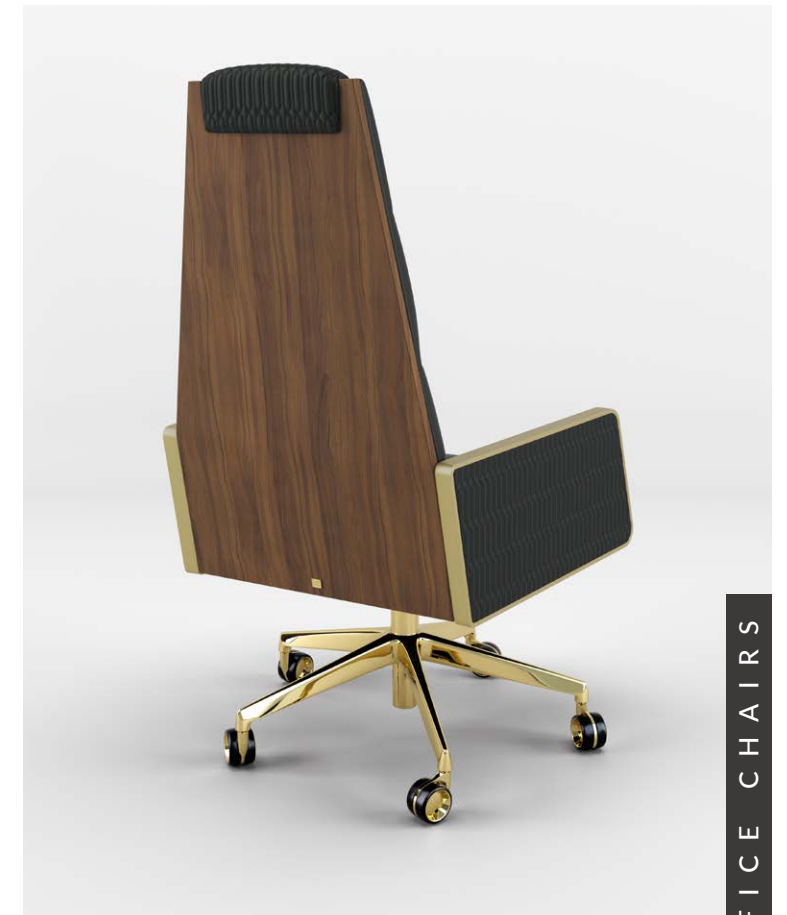

Lucidatura/Finishing/Отделка/饰面  
70. CANALETTO WALNUT MATT

Parti in metallo/Metal parts/Металлическая фурнитура/金属部件  
SATIN GOLD - GOLD

Struttura in legno massello. Parte interna e braccioli in pelle ricamata. Parte esterna disponibile in essenza di noce canaletto. Telaio braccioli in metallo satinato. Imbottiture in poliuretano a quote differenziate. Base a 5 razze in metallo con ruote "Design", regolabile in altezza.

Solid wood frame. Quilted leather inner body and armrests. Canaletto walnut wooden veneer outer body. Satin metal armrests frame. Multiple densities polyurethane foam padding. 5 feet metal base with "Design" wheels, adjustable height.

Рама из массива дерева. Внутренняя часть каркаса и подлокотники из стеганой кожи. Внешняя часть каркаса из шпона ореха каналетто. Рама подлокотников из сатинового металла. Набивка из пенополиуретана разной плотности. Металлическая основа с 5 роликами Design, регулируемая высота.

实木框架。内部框架和扶手采用绗缝皮革。外部框架采用卡纳莱托胡桃木饰面。缎纹金属扶手框架。多重密度聚氨酯泡沫填充垫料。5英尺金属底座配有“专属设计”椅轮，高度可调。

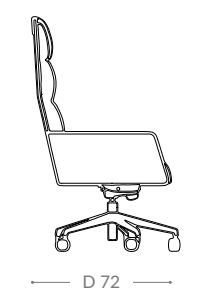
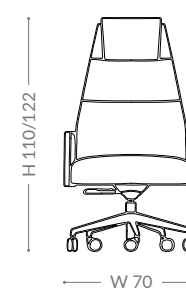



ZB

# MIRRORS



# ARTEMIDE

MIRROR

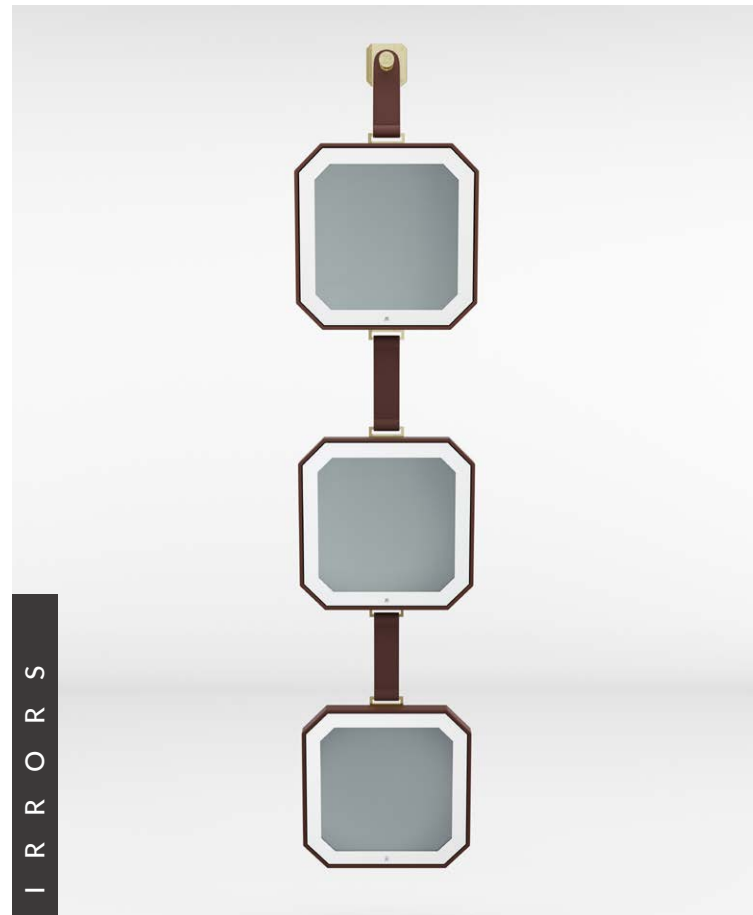

**As picture: Artemide mirror**  
In price list: Prime

Lucidatura/Finishing/Отделка/饰面  
91. BURGUNDY MATT

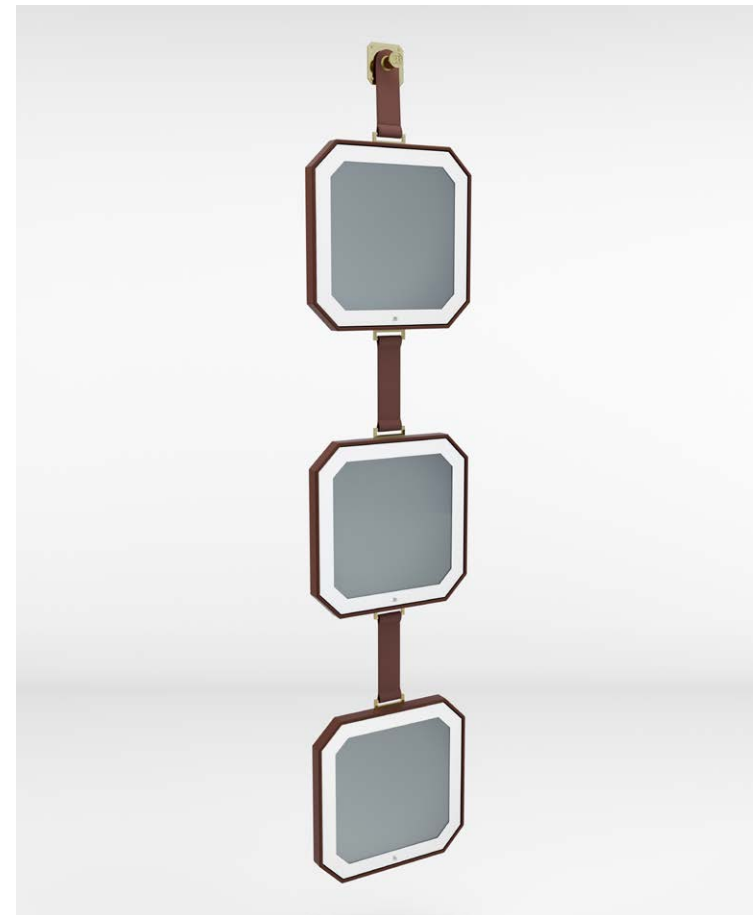

Materiale/Material/Материал/材料  
BZ 906-2030 LEATHER BURGUNDY

Parti in metallo/Metal parts/Металлическая фурнитура/金属部件  
GOLD

Specchio extra bright con perimetro sabbiato su supporto in multistrati di legno laccato. Composto da 3 elementi uniti da cintura in pelle e ganci metallici. Predisposto per aggancio a parete.

Extra bright mirror with sandblasted profile on plywood lacquered support. Composed by 3 elements joined with leather band and metal hooks. Wall fittings included.

Очень яркое зеркало с профилем, подвергнутым пескоструйной обработке, на лакированной основе из фанеры. Состоит из 3 элементов, соединенных кожаным ремешком и металлическими крючками. Настенные крепления входят в комплект.

超亮镜面，喷砂工艺轮廓线条，喷漆胶合板底座。整体由三个部分组成，通过皮带和金属挂钩连在一起。含挂墙配件。

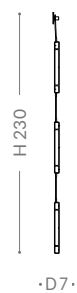
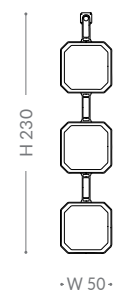

# CONSTANCE

MIRROR



**As picture: Constance mirror**  
In price list: Brilliant

Lucidatura/Finishing/Отделка/饰面  
57. CHOCOLATE  
65. MAKASSAR



Parti in metallo/Metal parts/Металлическая фурнитура/金属部件  
GOLD

Struttura in metallo con cornice e formelle in legno laccato. Specchio centrale convesso. Dettagli in metallo e ebano makassar.

Metal structure with laquered wooden frame and decorative tiles. Convex mirror. Metal and ebony makassar details.

Металлический каркас с лакированной деревянной рамой и декоративными плитками. Выпуклое зеркало. Детали из металла и макаassarского эбена.

金属架构，漆木镜框，饰以装饰拼贴。凸面镜。点缀金属和孟加锡乌木细节。

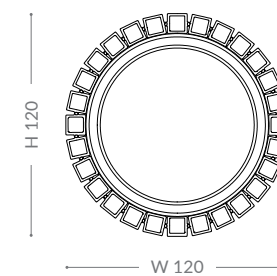

# ETIENNE

MIRROR

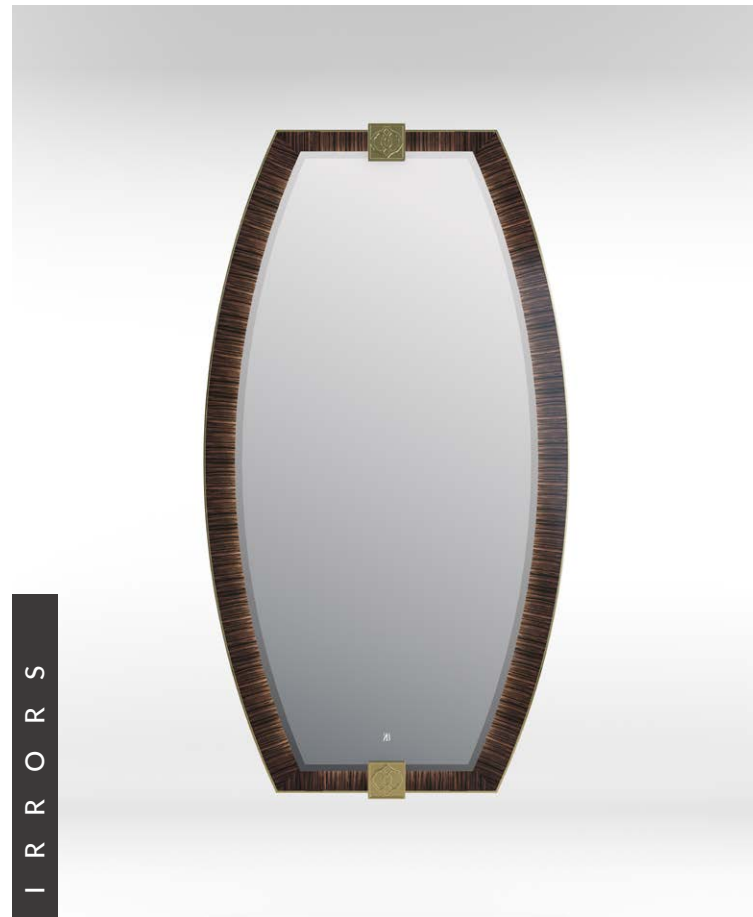

**As picture: Etienne large mirror**  
In price list: Brilliant



Lucidatura/Finishing/Отделка/饰面  
57. CHOCOLATE  
65. MAKASSAR

Parti in metallo/Metal parts/Металлическая фурнитура/金属部件  
GOLD

Struttura in multistrati di legno con profili in metallo. Specchio extra white e supporti in ottone. Disponibile in legno laccato, essenza di ebano makassar o essenza di palissandro; con illuminazione a LED. Dimensioni previste: grande e piccola.

Plywood structure with metal profiles. Extra white mirror with brass supports. Available in lacquered wood, makassar ebony or palisander veneer; LED lighting included. Available sizes: large and small.

Каркас из фанеры с металлическими профилями. Осветленное зеркало с опорами из латуни. Доступные материалы: лакированная древесина или шпон макассарского эбена или шпон палисандра. Светодиодная подсветка входит в комплект. Доступные размеры: большое и маленькое зеркало.

胶合板架结构, 金属轮廓线条。超白镜面, 黄铜底座。可选漆木, 孟加锡乌木饰面或花梨木饰面板, 含 LED 照明。可选尺寸: 大号和小号。

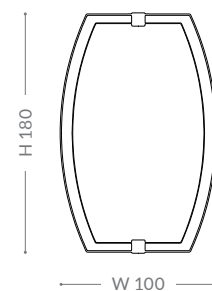

ETIENNE large

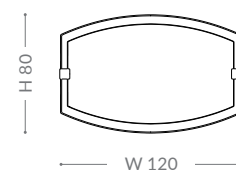

ETIENNE small

# FLYNN

MIRROR

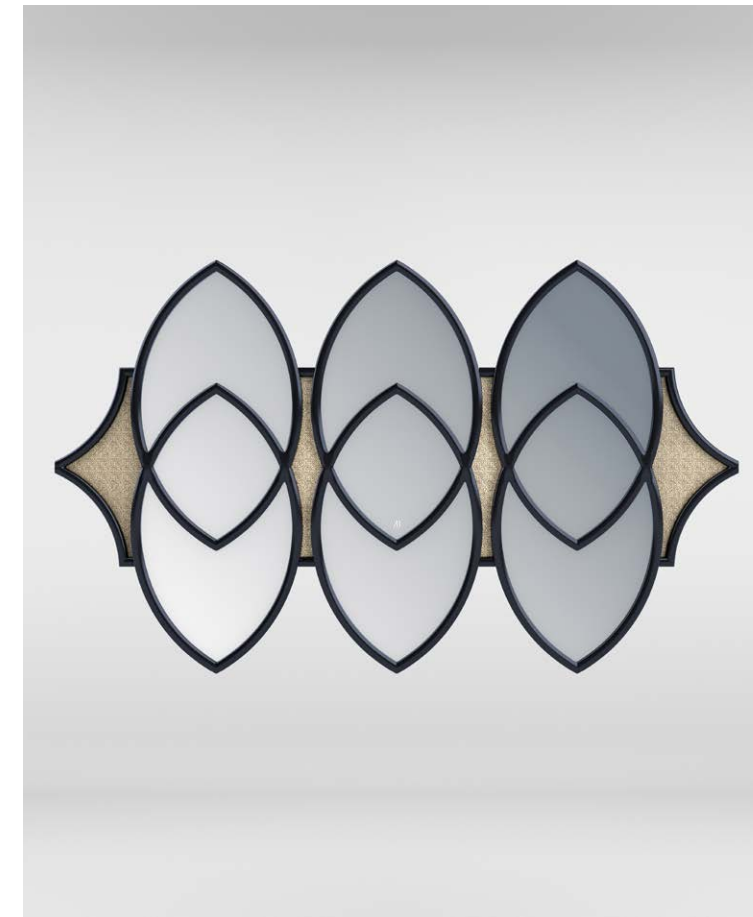

**As picture: Flynn mirror**  
In price list: Brilliant

Lucidatura/Finishing/Отделка/饰面  
57. CHOCOLATE

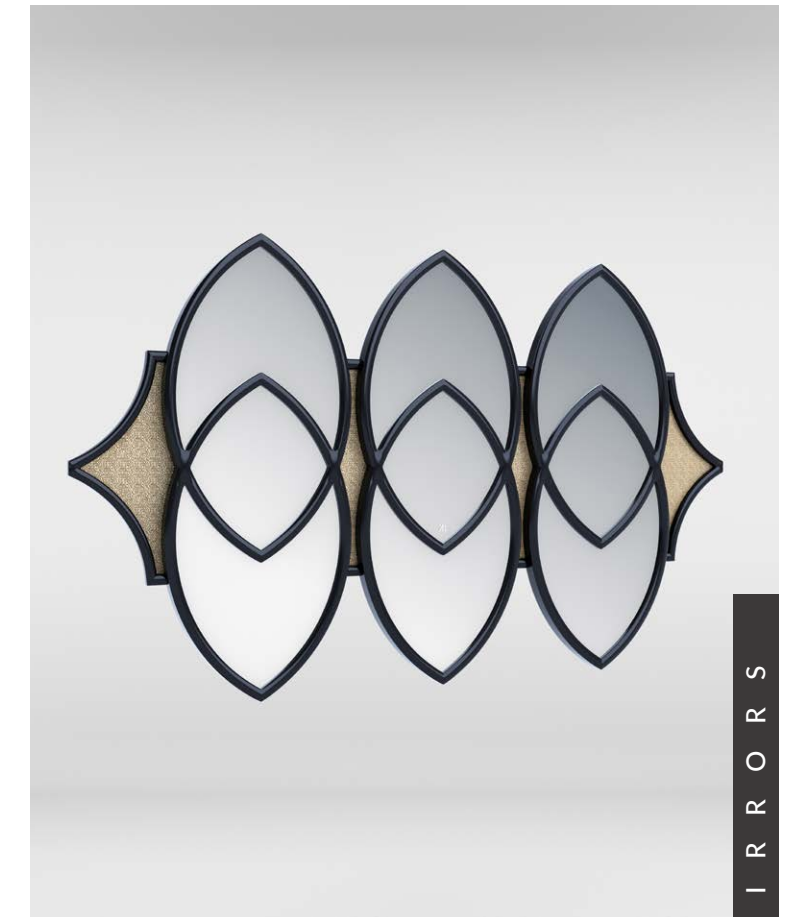

Materiale/Material/Материал/材料  
BZ 188-07 BOUCLÉ SAND

Struttura realizzata in multistrati di legno e legno massello. Decorata con pannello rivestito in tessuto. Specchio extra white.

Plywood and solid wood structure. Decorated with fabric covered panel. Extra white mirror.

Каркас из фанеры и массива дерева. Отделка из панели, обитой тканью. Осветленное зеркало.

胶合板和实木结构。布艺包面板材。超白镜面。

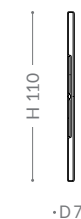
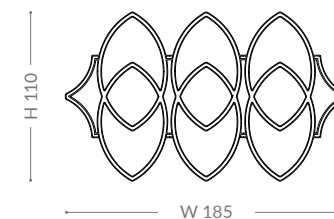

# IKE

MIRROR

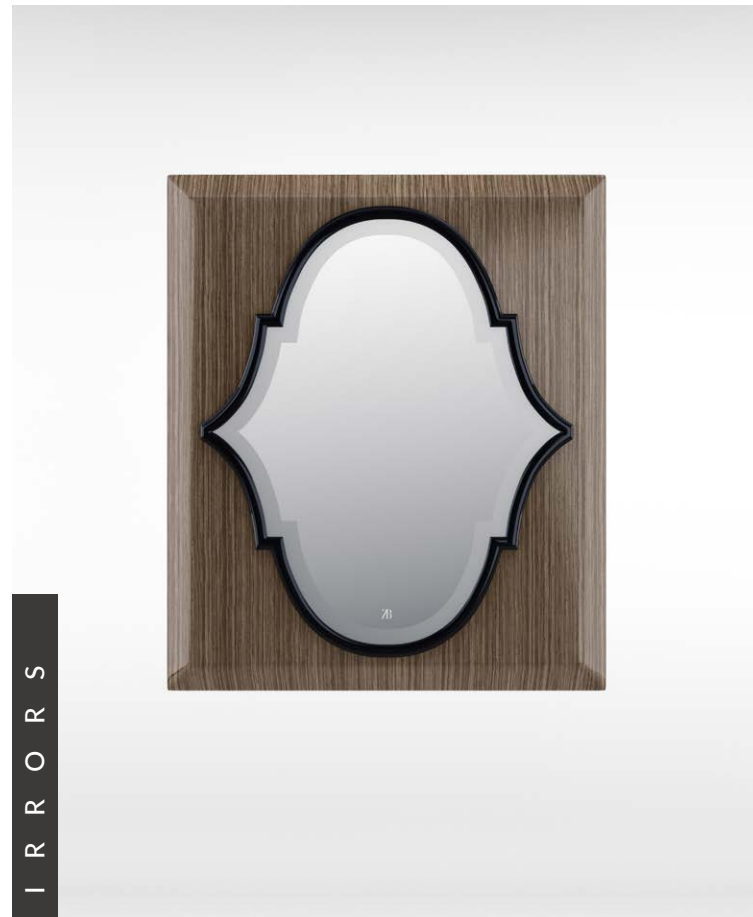

M I R R O R S



**As picture: Ike mirror**  
In price list: Brilliant

Lucidatura/Finishing/Отделка/饰面  
64. CANALETTO WALNUT  
57. CHOCOLATE

Pannello in multistrati di legno e MDF. Disponibile in legno laccato, ebano makassar o noce canaletto. Specchio centrale extra white.

Plywood and MDF panel. Available in lacquered wood, makassar ebony or canaletto walnut veneer. Extra white central mirror.

Панель из фанеры и МДФ. Доступные материалы: лакированная древесина, шпон макассарского эбена и ореха каналетто. Осветленное центральное зеркало.

胶合板和中密度纤维板。可选用漆木、孟加锡乌木或卡纳莱托胡桃木饰面。超白中心镜。

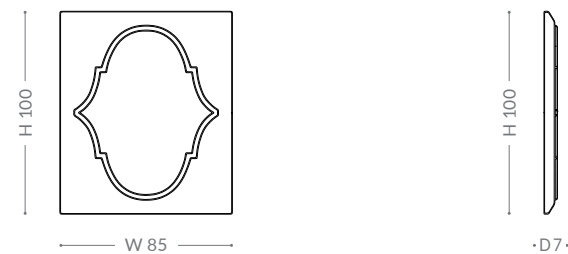

# JUPITER

MIRROR



**As picture: Jupiter mirror**  
In price list: Brilliant

Lucidatura/Finishing/Отделка/饰面  
64. CANALETTO WALNUT  
57. CHOCOLATE

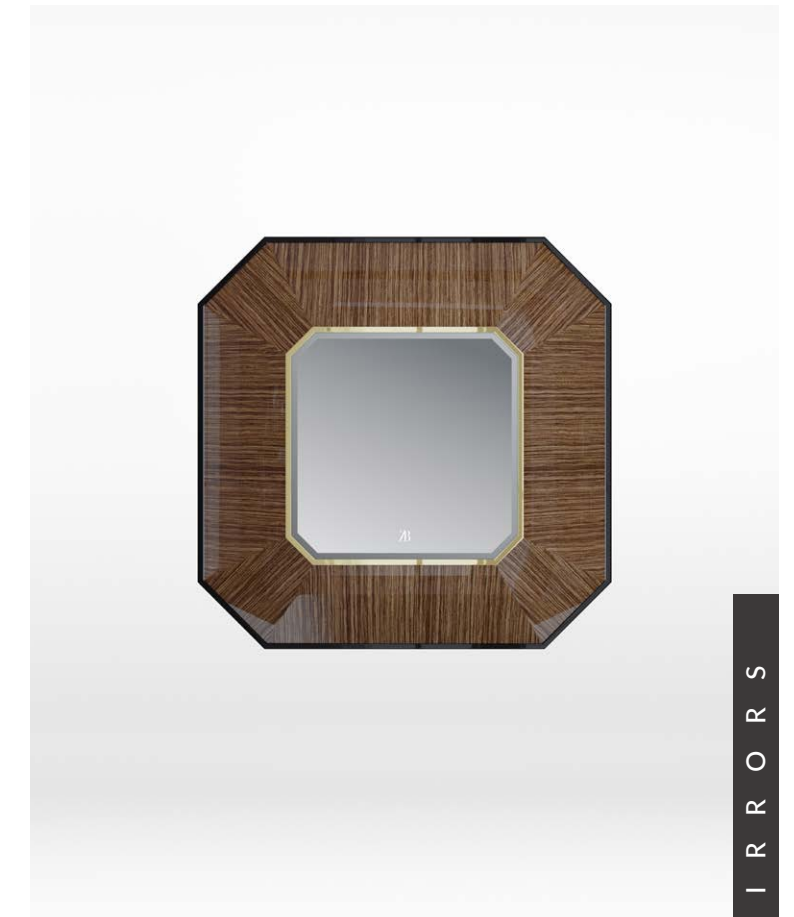

Parti in metallo/Metal parts/Металлическая фурнитура/金属部件  
GOLD

Pannello in multistrati di legno con perimetro laccato e viti decorative. Disponibile in legno laccato, ebano makassar o noce canaletto. Dettaglio in metallo. Specchio centrale extra white.

Plywood panel with lacquered profile and decorative screws. Available in lacquered wood, makassar ebony or canaletto walnut veneer. Metal details. Extra white central mirror.

Панель из фанеры с лакированным профилем и декоративными болтами. Доступные материалы: лакированная древесина, шпон макассарского эбена и ореха каналетто. Металлические детали. Осветленное центральное зеркало.

胶合板材，喷漆轮廓处理，点缀装饰螺钉。可选用漆木、孟加锡乌木或卡纳莱托胡桃木饰面。精细金属配饰。超白中心镜。

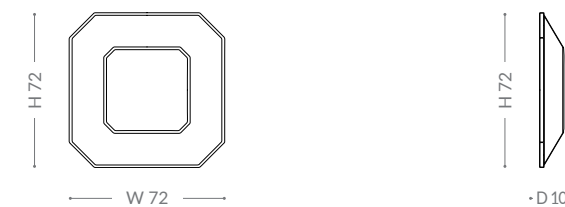

M I R R O R S



# OSIRIS

RECTANGULAR MIRROR



M I R R O R S

**As picture: Osiris rectangular mirror**  
In price list: Prime



Lucidatura/Finishing/Отделка/饰面  
85. CHOCOLATE MATT

Materiale/Material/Материал/材料  
BZ 906-2003 LEATHER DARK BROWN

Struttura in legno rivestita in pelle e pannello in multistrati di legno laccato. Specchio extra white.

Leather covered wooden structure and lacquered plywood panel. Extra white mirror.

Каркас из древесины, покрытой кожей, и панель из лакированной фанеры. Осветленное зеркало.

皮革包裹木质架构和喷漆胶合板材。超白镜面。

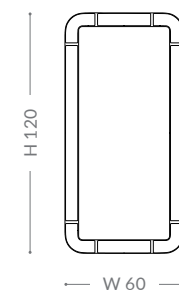

# OSIRIS

ROUND MIRROR



**As picture: Osiris round mirror**  
In price list: Prime

Lucidatura/Finishing/Отделка/饰面  
80. IVORY MATT

Materiale/Material/Материал/材料  
BZ 905-5234 LEATHER BEIGE

Struttura in legno rivestita in pelle e pannello in multistrati di legno laccato. Specchio extra white.

Leather covered wooden structure and lacquered plywood panel. Extra white mirror.

Каркас из древесины, покрытой кожей, и панель из лакированной фанеры. Осветленное зеркало.

皮革包裹木质架构和喷漆胶合板材。超白镜面。

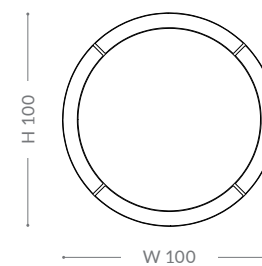

M I R R O R S

# SHIRLEY

MIRROR

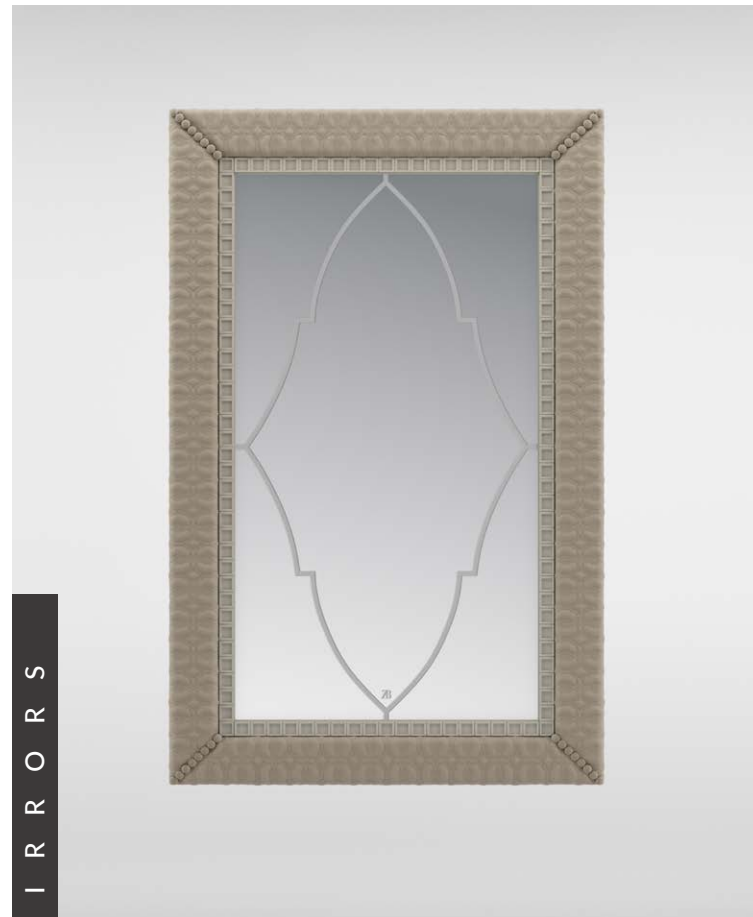

M I R R O R S

**As picture: Shirley mirror**  
In price list: Brilliant



Lucidatura/Finishing/Отделка/饰面  
53. DOVE GREY

Materiale/Material/Материал/材料  
BZ 904-4632 LEATHER SAND

Pannello in multistrati di legno, rivestito in pelle ricamata. Decorato con cornice traforata in legno laccato. Specchio extra white con disegno sabbato.

Plywood panel, covered in quilted leather. Lacquered wooden fretwork frame. Extra white mirror with sandblasted decoration.

Панель из фанеры, обитая стеганой кожей. Резная рама из лакированной древесины. Осветленное зеркало с декоративными элементами, выполненными с помощью пескоструйной обработки.

胶合板材质地，包裹绗缝皮革。漆木浮雕细工镜框。超白镜面，点缀喷砂装饰。

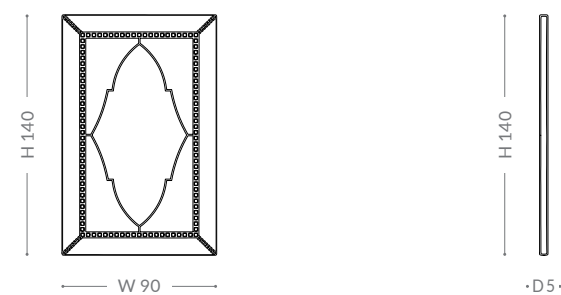

# TWIN

MIRROR



**As picture: Twin mirror**  
In price list: Prime

Lucidatura/Finishing/Отделка/饰面  
85. CHOCOLATE MATT

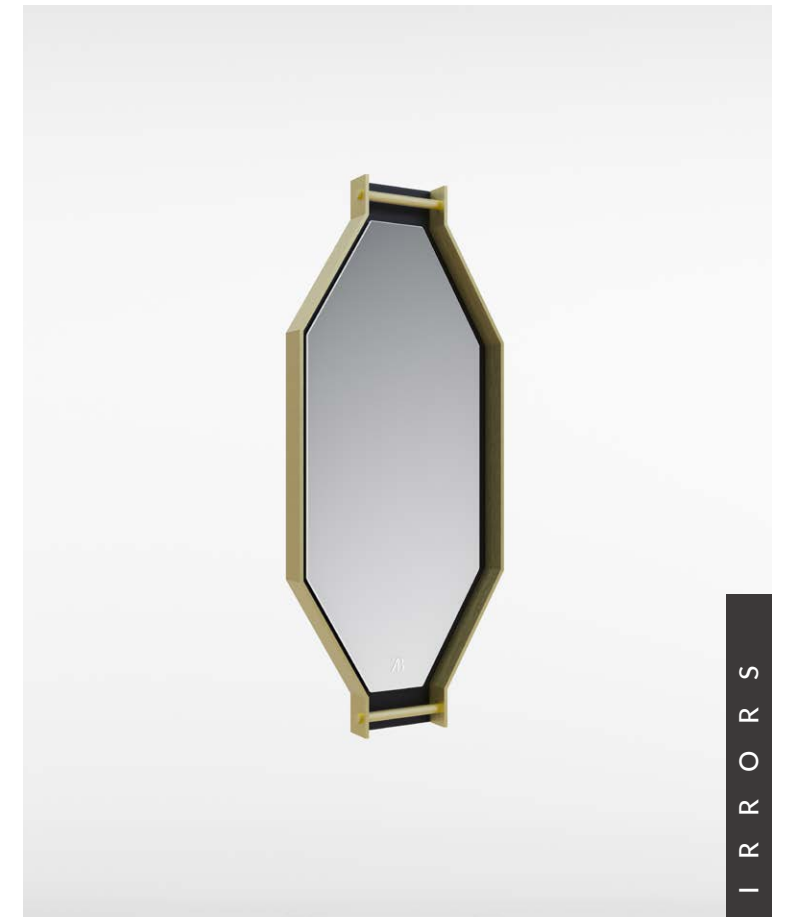

Parti in metallo/Metal parts/Металлическая фурнитура/金属部件  
SATIN GOLD

Struttura in metallo satinato e pannello in multistrati di legno laccato. Specchio extra white.

Satin metal and lacquered plywood structure. Extra white mirror.

Каркас из сатинированного металла и лакированной фанеры. Осветленное зеркало.

缎纹金属和漆木胶合板结构。超白镜面。

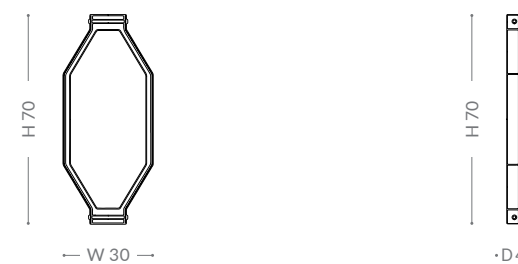

M I R R O R S

# TWIN

## MIRRORS COMPOSITION 1

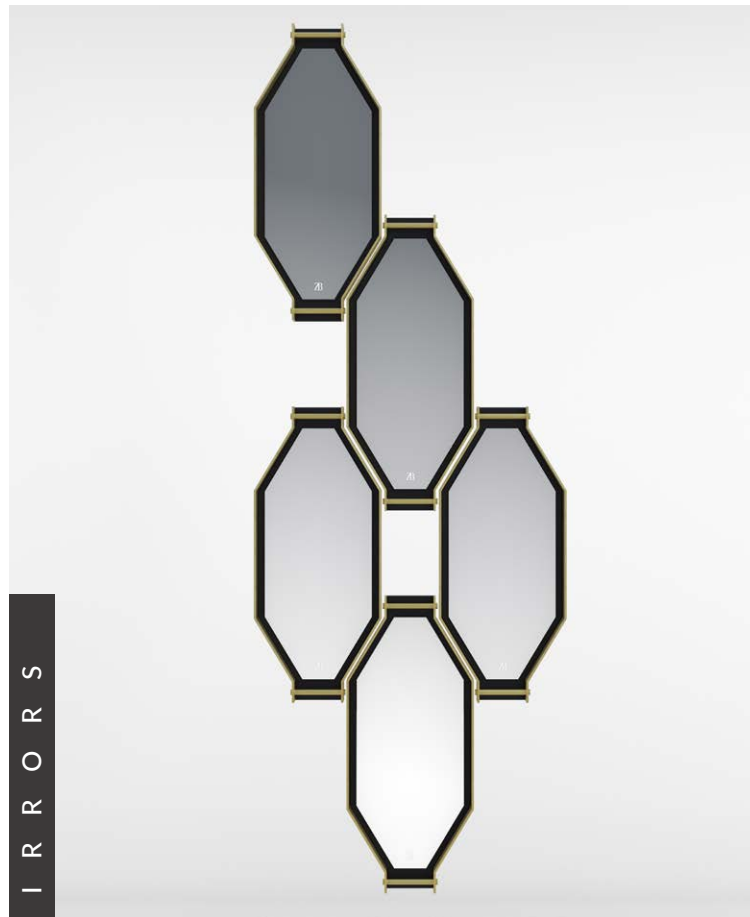

M I R R O R S

**As picture: Twin mirrors composition 1**  
In price list: Prime



Lucidatura/Finishing/Отделка/饰面  
85. CHOCOLATE MATT

Parti in metallo/Metal parts/Металлическая фурнитура/金属部件  
SATIN GOLD

Struttura in metallo satinato e pannello in multistrati di legno laccato. Specchio extra white. Composizione: 5 elementi singoli in posizione verticale.

Satin metal and lacquered plywood structure. Extra white mirror. Composition: 5 single elements, vertically positioned.

Каркас из сатинового металла и лакированной фанеры. Осветленное зеркало. Композиция: 5 отдельных элементов, расположенных вертикально.

缎纹金属和漆木胶合板结构。超白镜面。组成部分：5个独立组成部分，竖直放置。



# TWIN

## MIRRORS COMPOSITION 2



**As picture: Twin mirrors composition 2**  
In price list: Prime



Lucidatura/Finishing/Отделка/饰面  
81. SAND MATT

Parti in metallo/Metal parts/Металлическая фурнитура/金属部件  
SATIN TITANIUM

Struttura in metallo satinato e pannello in multistrati di legno laccato. Specchio extra white. Composizione: 5 elementi singoli in posizione orizzontale.

Satin metal and lacquered plywood structure. Extra white mirror. Composition: 5 single elements, horizontally positioned.

Каркас из сатинового металла и лакированной фанеры. Осветленное зеркало. Композиция: 5 отдельных элементов, расположенных горизонтально.

缎纹金属和漆木胶合板结构。超白镜面。组成部分：5个独立组成部分，水平放置。

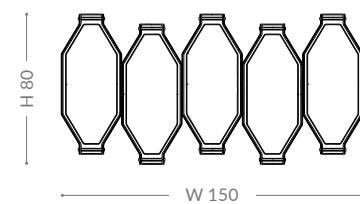

M I R R O R S



ZB

# DECORATIONS



# ARES

PANELING

DECORATIONS

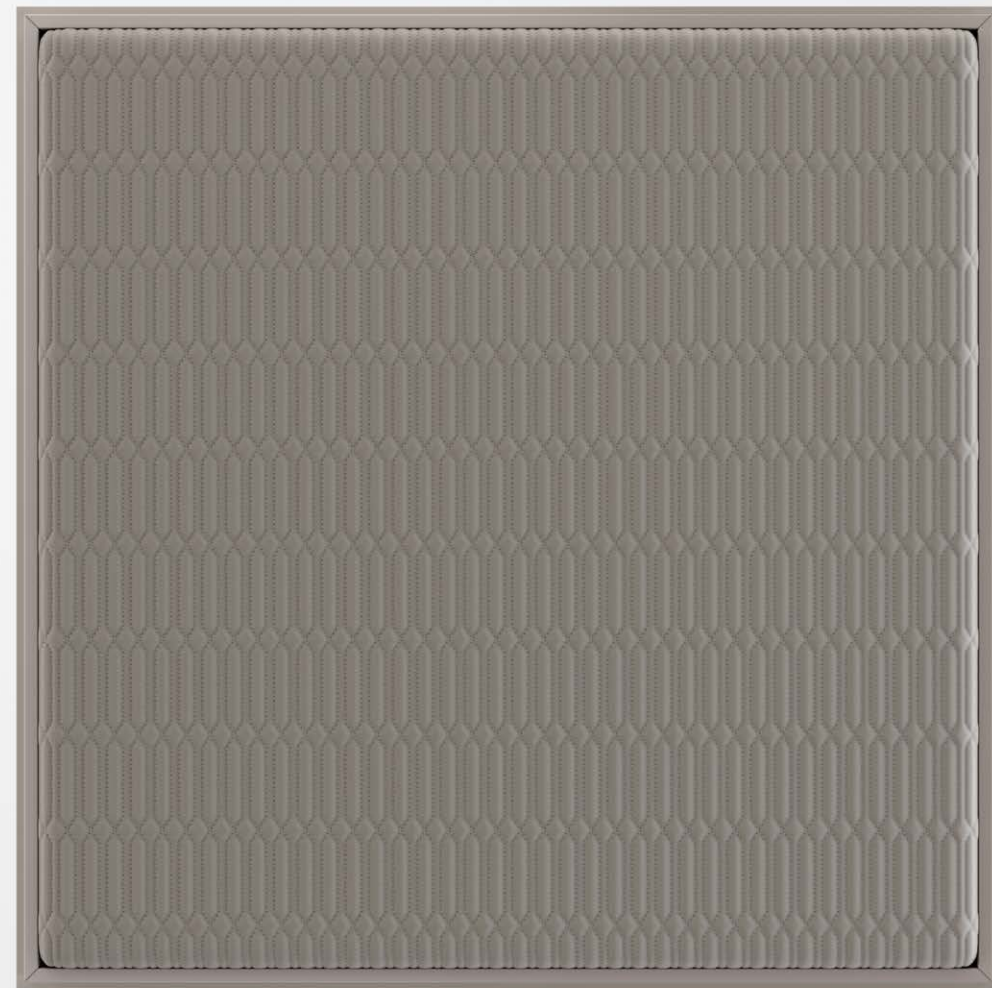

As picture: Ares paneling  
In price list: Prime

Lucidatura/Finishing/Отделка/饰面  
99. DOVE GREY MATT

Materiale/Material/Материал/材料  
BZ 186-091 DOVE GREY

Pannello in multistrati di legno e legno massello, rivestito in tessuto e decorato con ricamo. Disponibile come elemento singolo o come composizione modulare.

Plywood panel and solid wooden panel, covered in fabric, with quilted decoration. Available as single element or modular composition.

Панель из фанеры и панель из массива древесины, покрытая тканью и украшенная стеганой обивкой. Доступна в качестве отдельного элемента или модульной композиции.

胶合板材和实木板材，采用绗缝装饰的布艺包面。可单选或多选进行模块组合。

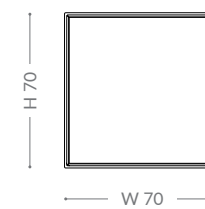
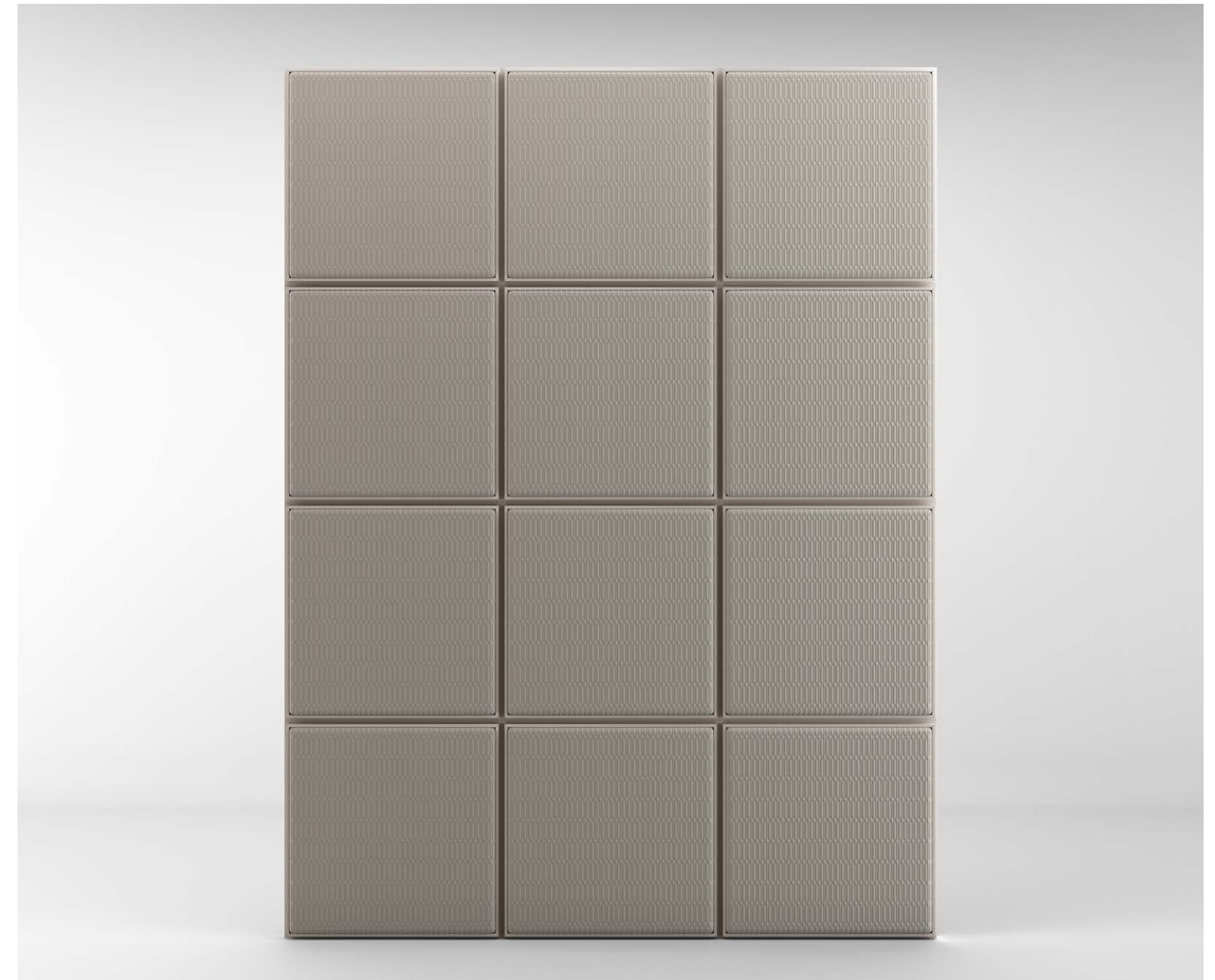

# BAUHAUS

COLUMN

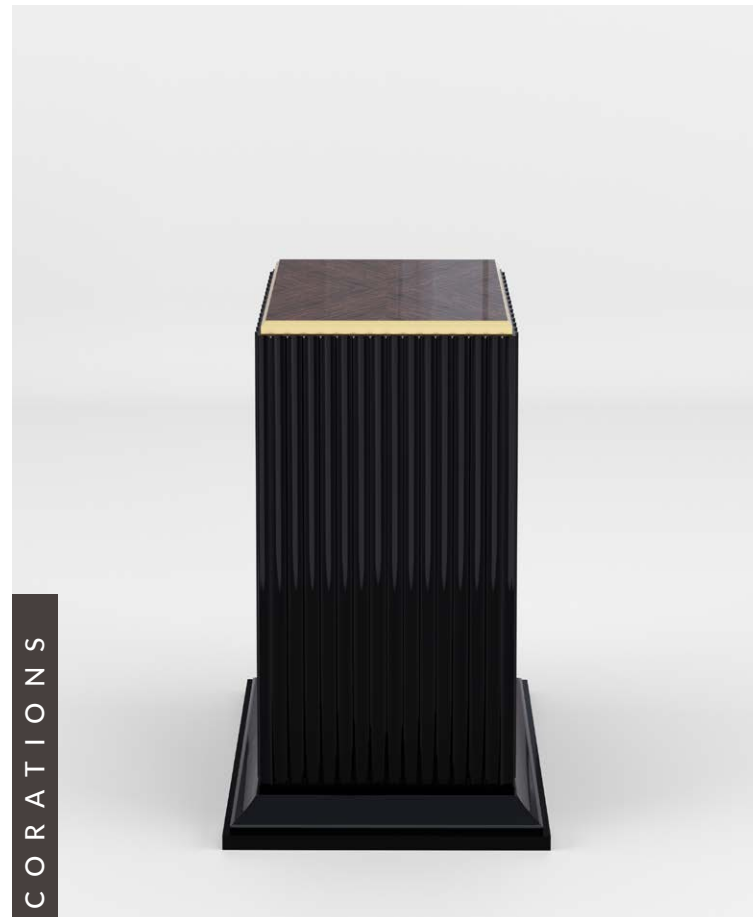

DECORATIONS

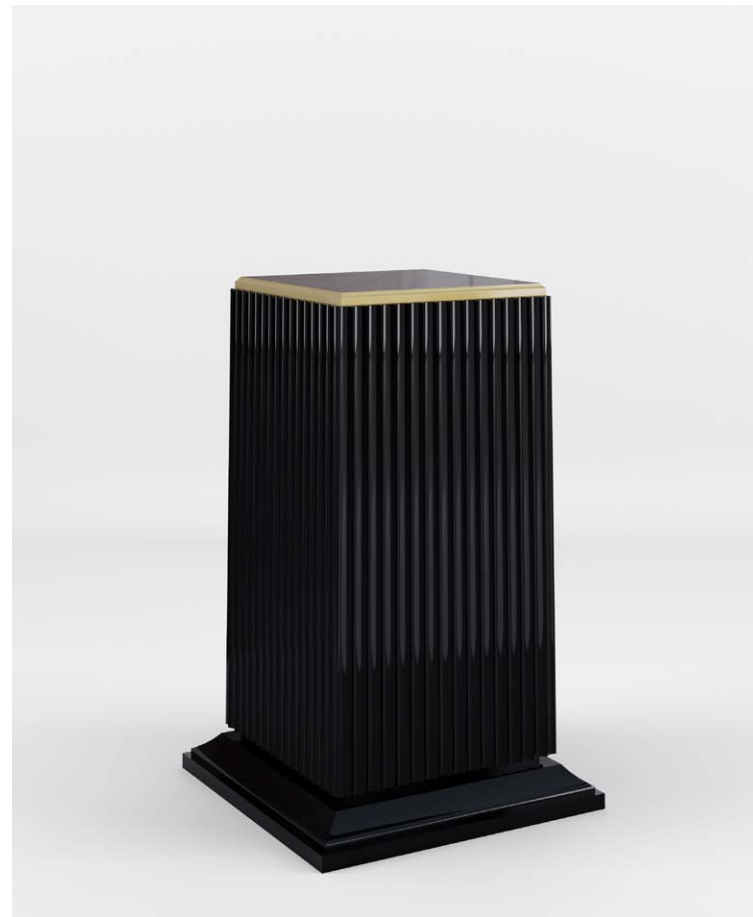

**As picture: Bauhaus column 80**  
In price list: Brilliant

Lucidatura/Finishing/Отделка/饰面  
57. CHOCOLATE  
65. MAKASSAR  
61. DIAMOND GOLD

Struttura in legno massello e multistrati di legno. Disponibile con piano laccato, in essenza di ebano makassar o noce canaletto.

Solid wood and plywood structure. Top available in lacquered wood, makassar ebony veneer or canaletto walnut veneer.

Каркас из массива дерева и фанеры. Доступные материалы верха: лакированная древесина, шпон макассарского эбена или ореха каналетто.

实木和胶合板结构。台面可选用漆木、孟加锡乌木或卡纳莱托胡桃木饰面。

# CLUB

COLUMN



**As picture: Club column**  
In price list: Brilliant

Lucidatura/Finishing/Отделка/饰面  
57. CHOCOLATE  
64. CANALETTO WALNUT

Struttura in legno massello e multistrati di legno. Pannello centrale disponibile in noce canaletto.

Solid wood and plywood structure. Central panel available in canaletto walnut veneer.

Каркас из массива дерева и фанеры. Центральная панель из древесины ореха каналетто.

实木和胶合板结构。中心位置板材为卡纳莱托胡桃木质地。

DECORATIONS

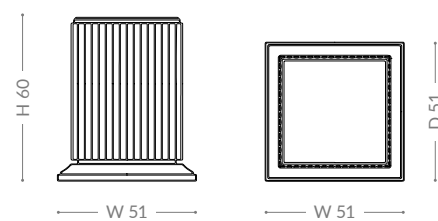

BAUHAUS 60

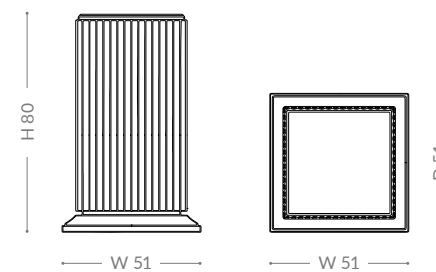

BAUHAUS 80

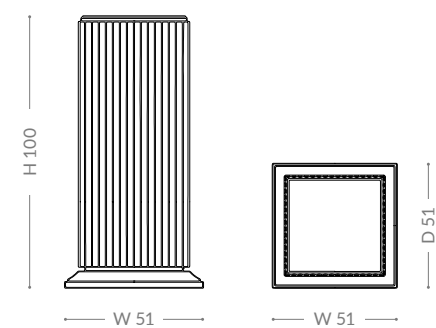

BAUHAUS 100

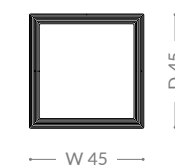
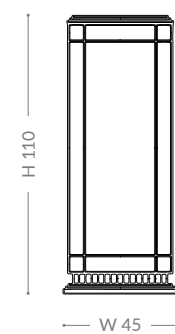

# EOLO

SAIL

DECORATIONS



**As picture: Eolo sail**  
In price list: Brilliant/Mosaic on request

Lucidatura/Finishing/Отделка/饰面  
69. CANALETTO WALNUT

Parti in metallo/Metal parts/Металлическая фурнитура/金属部件  
SATIN TITANIUM

Separé mobile realizzato in legno con decorazione in pelle ricamata. Decorazione con mosaico su richiesta. Disponibile in essenza di noce canaletto. Viene fornito con agganci e distanziali rotanti in metallo.

Pivoting wooden screen, decorated with quilted leather. Mosaic decoration on request. Available in canaletto walnut veneer. With metal hooks and rotating spacers.

Вращающаяся деревянная перегородка, украшенная стеганой кожей. Украшение из мозаики по заказу. Шпон ореха каналетто. Имеются металлические крючки и вращающиеся вставки.

旋转木质屏风，点缀绗缝皮革。也可根据要求镶嵌图案。卡纳莱托胡桃木饰面。配有金属钩和旋转垫片。

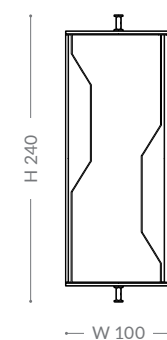

CENTRAL ELEMENT

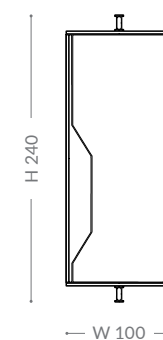

SIDE ELEMENT



D9

# LEONE

WOOD SCREEN

DECORATIONS



As picture: Leone wood screen  
In price list: Prime

Lucidatura/Finishing/Отделка/饰面  
70. CANALETTO WALNUT MATT

Parti in metallo/Metal parts/Металлическая фурнитура/金属部件  
GOLD

Filtro/separé realizzato in noce canaletto e metallo. Disponibile come elemento singolo o come composizione modulare.

Screen/grid wall; canaletto walnut wood and metal structure. Available as single element or modular composition.

Ширма/перегородка. Каркас из древесины ореха каналетто и металла. Доступна в качестве отдельного элемента или модульной композиции.

屏风/格栅墙；卡纳莱托胡桃木和金属结构。可单选或多选进行模块组合。

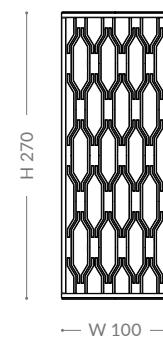
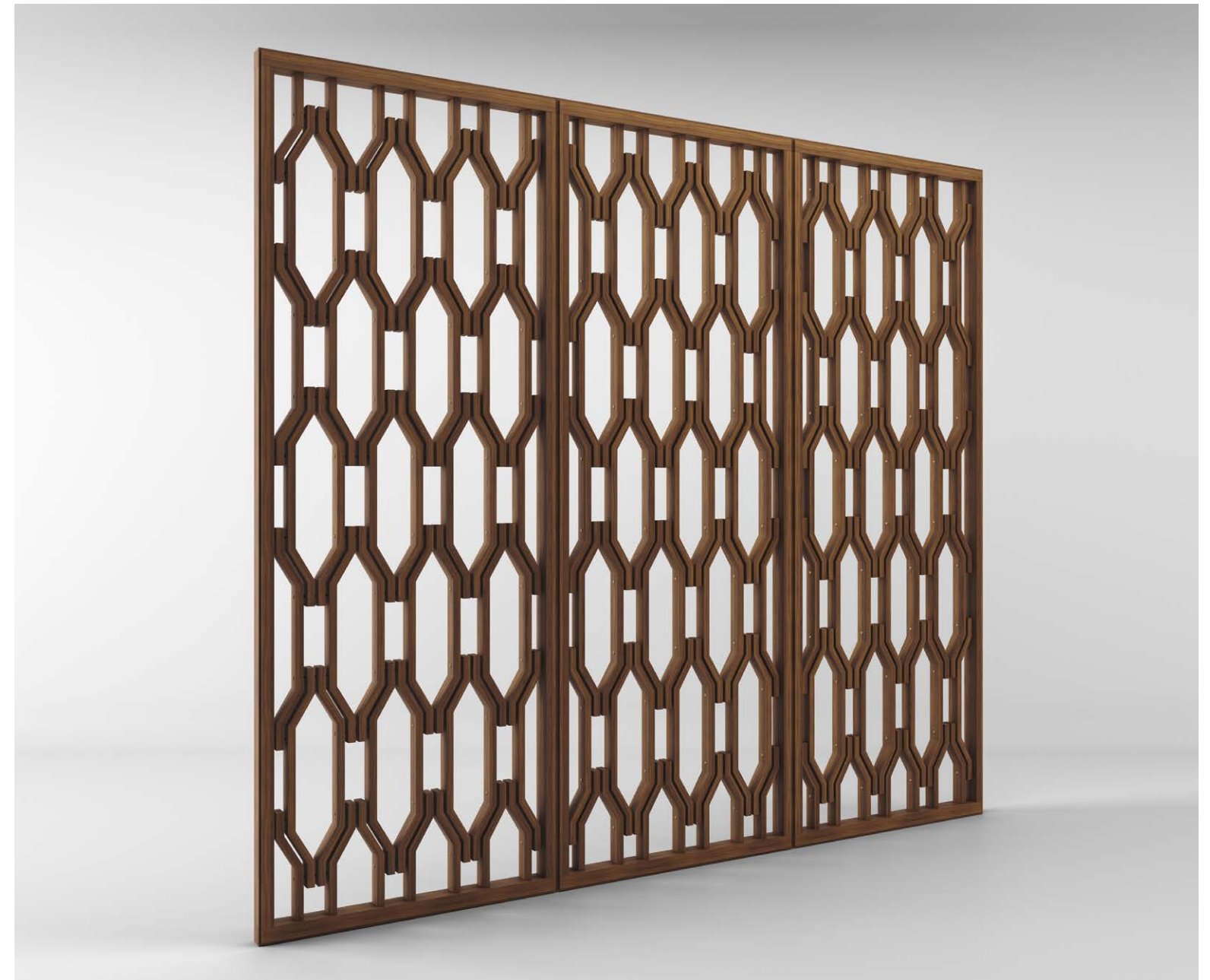



# ODISSEY

SCREEN

DECORATIONS



As picture: Odissey screen  
In price list: Brilliant

Lucidatura/Finishing/Отделка/饰面  
57. CHOCOLATE

Parti in metallo/Metal parts/Металлическая фурнитура/金属部件  
GOLD

Filtro/separé realizzato in legno massello laccato e metallo. Parte centrale decorata con logo. Disponibile come elemento singolo o come composizione modulare.

Screen/grid wall; lacquered wood and metal structure. Center decorated with logo. Available as single element or modular composition.

Ширма/перегородка. Каркас из лакированной древесины и металла. Центральная часть украшена логотипом. Доступна в качестве отдельного элемента или модульной композиции.

屏风/格栅墙；漆木和金属结构。中心位置以徽标点缀。可单选或多选进行模块组合。

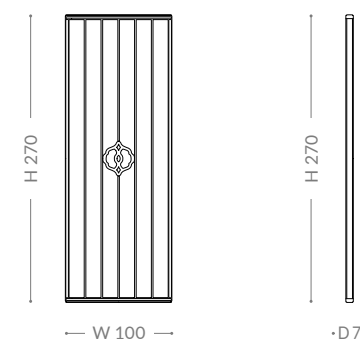



# AMBASSADOR

RUG



RUGS

**As picture: Ambassador rug**  
cm 400x300  
In price list: Prime

Tappeto/Rug/Ковер/地毯  
TENCEL SAND

Decorazione/Decoration/  
Декоративный элемент/装饰  
TENCEL CARAMEL

Tappeto "hand tufted" con disegno "natura" a contrasto. Composizione: 100% Tencel. Disponibile con fondo color sabbia e disegno color caramello.

Hand tufted rug with contrasting nature pattern decoration. 100% Tencel. Available in sand color with caramel decoration.

Изготовленный вручную ковер с шитым ворсом, украшенный рисунком контрастного цвета с изображением природы. 100%-я ткань тенсел. Песочный цвет с отделкой карамельного оттенка.

手工植绒地毯，凸显对比的自然图案装饰。100% Tencel 纤维。沙色配焦糖色装饰图案。



AMBASSADOR cm 300x250



AMBASSADOR cm 400x300



AMBASSADOR cm 400x400

# ASTORIA

RUG

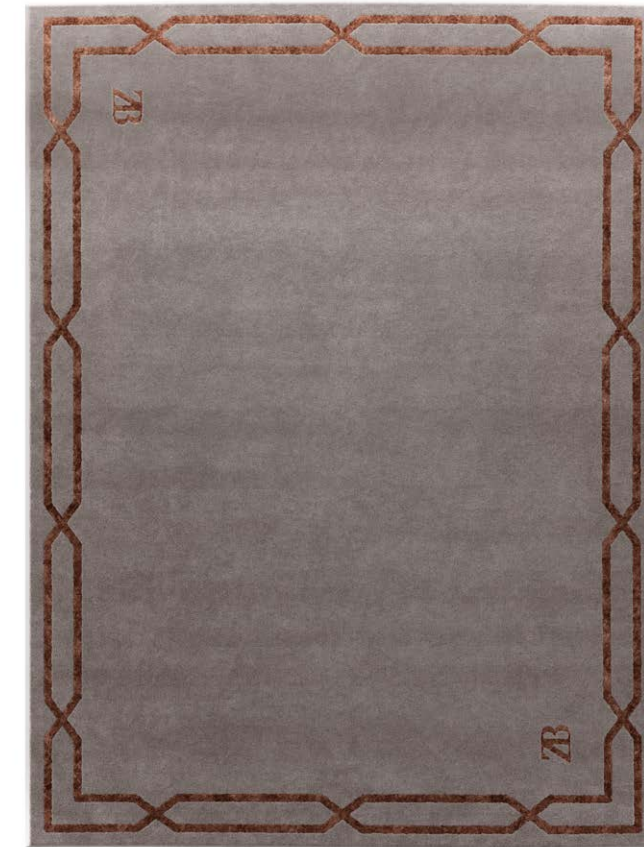

**As picture: Astoria rug**  
cm 400x300  
In price list: Prime

Tappeto/Rug/Ковер/地毯  
TENCEL DOVE GREY

Decorazione/Decoration/  
Декоративный элемент/装饰  
TENCEL RUST

Tappeto "hand tufted" con disegno "twin" a contrasto sul perimetro. Composizione: 100% Tencel. Disponibile con fondo color tortora e disegno color ruggine.

Hand tufted rug with contrasting "twin" pattern decoration on profile. 100% Tencel. Available in dove-grey color with rust decoration.

Изготовленный вручную ковер с шитым ворсом, украшенный двойным рисунком контрастного цвета по контуру. 100%-я ткань тенсел. Голубовато-серый цвет, отделка цвета ржавчины.

手工植绒地毯，边缘点缀对称对比色图案。100% Tencel 纤维。鸽灰色配铁锈色装饰。

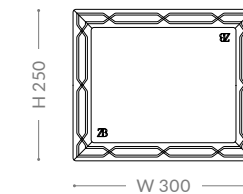

ASTORIA cm 300x250

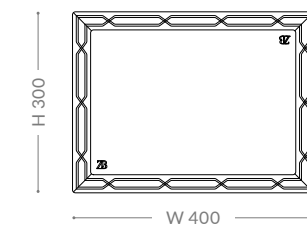

ASTORIA cm 400x300

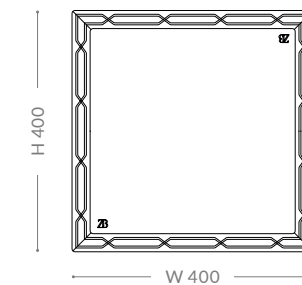

ASTORIA cm 400x400

RUGS

# CLUB

CARVED RUG



RUGS

As picture: Club rug  
cm 400x300  
In price list: Prime

Tappeto/Rug/Ковер/地毯  
BANANA FIBER VISCOSE IVORY

Tappeto "hand tufted" con disegno geometrico intagliato. Composizione: 100% "Banana Fiber". Disponibile in colore avorio.

Hand tufted rug with carved geometric pattern. 100% "Banana Fiber". Available in ivory color.

Изготовленный вручную ковер с шитым ворсом, украшенный резным геометрическим рисунком. 100%-е банановое волокно. Цвет слоновой кости.

手工植绒地毯，剪花几何图案。100%“香蕉纤维”。可选象牙白色。

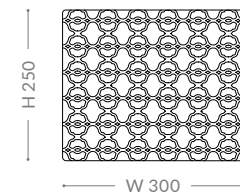

CLUB cm 300x250

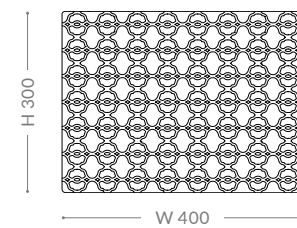

CLUB cm 400x300

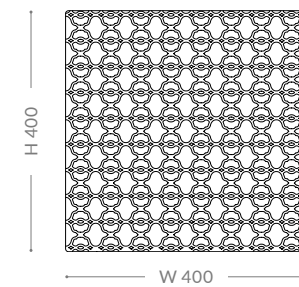

CLUB cm 400x400

# OCEAN

RUG



As picture: Ocean rug  
cm 400x300  
In price list: Prime

Tappeto/Rug/Ковер/地毯  
TENCEL SILK GREY  
TENCEL PEARL GREY  
TENCEL IVORY  
TENCEL PLUM  
TENCEL MAUVE

Tappeto "hand tufted" con disegno "astratto" a contrasto. Composizione: 100% Tencel. Disponibile con disegno in 5 colori: grigio perla, grigio seta, avorio, malva e prugna.

Hand tufted rug with contrasting abstract pattern. 100% Tencel. Available in 5 colors pattern: grey/pearl, satin grey, ivory, mauve and plum.

Изготовленный вручную ковер с шитым ворсом, украшенный абстрактным рисунком контрастного цвета. 100%-я ткань тенсел. Доступно с рисунком в 5 цветах: серый/жемчужный, сатиновый серый, цвет слоновой кости, розовато-лиловый и сливовый.

手工植绒地毯，凸显对比的抽象图案。100% Tencel 纤维。图案可选 5 种颜色：灰色/珍珠白，缎面灰色，象牙白色，淡紫色和深紫色。

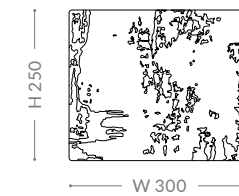

OCEAN cm 300x250

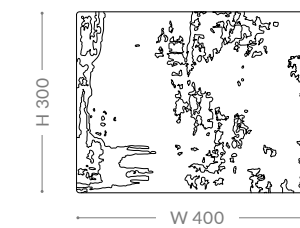

OCEAN cm 400x300

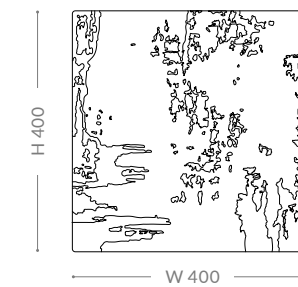

OCEAN cm 400x400

RUGS

# PETRUS

RUG

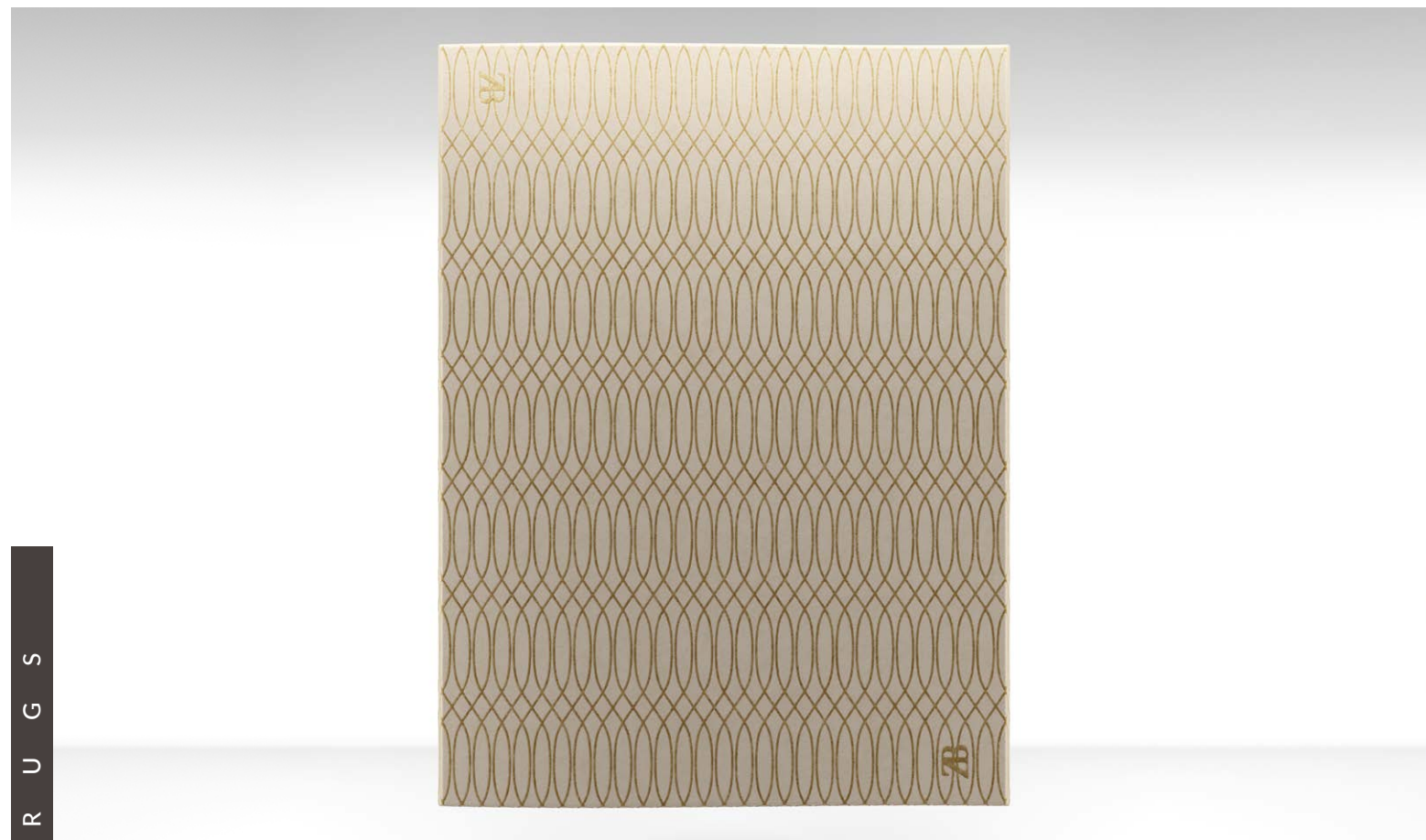

RUGS

**As picture: Petrus rug**  
cm 400x300  
In price list: Prime

Tappeto/Rug/Ковер/地毯  
WOOL IVORY  
WOOL CARAMEL

Tappeto "hand tufted" con disegno geometrico a contrasto. Composizione: 100% lana "New Zealand". Disponibile con fondo avorio e disegno caramello.

Hand tufted rug with contrasting geometric pattern. 100% "New Zealand" wool. Available in ivory color with caramel decoration.

Изготовленный вручную ковер с шитым ворсом, украшенный геометрическим рисунком контрастного цвета. 100%-я новозеландская шерсть. Цвет слоновой кости с отделкой карамельного оттенка.

手工植绒地毯，凸显对比的几何图案。100% 新西兰羊毛。象牙配焦糖色装饰。

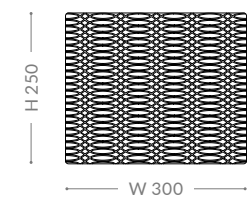

PETRUS cm 300x250

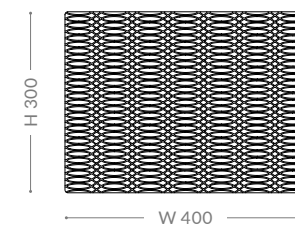

PETRUS cm 400x300

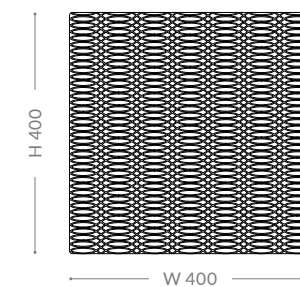

PETRUS cm 400x400

# SHIRLEY

RUG

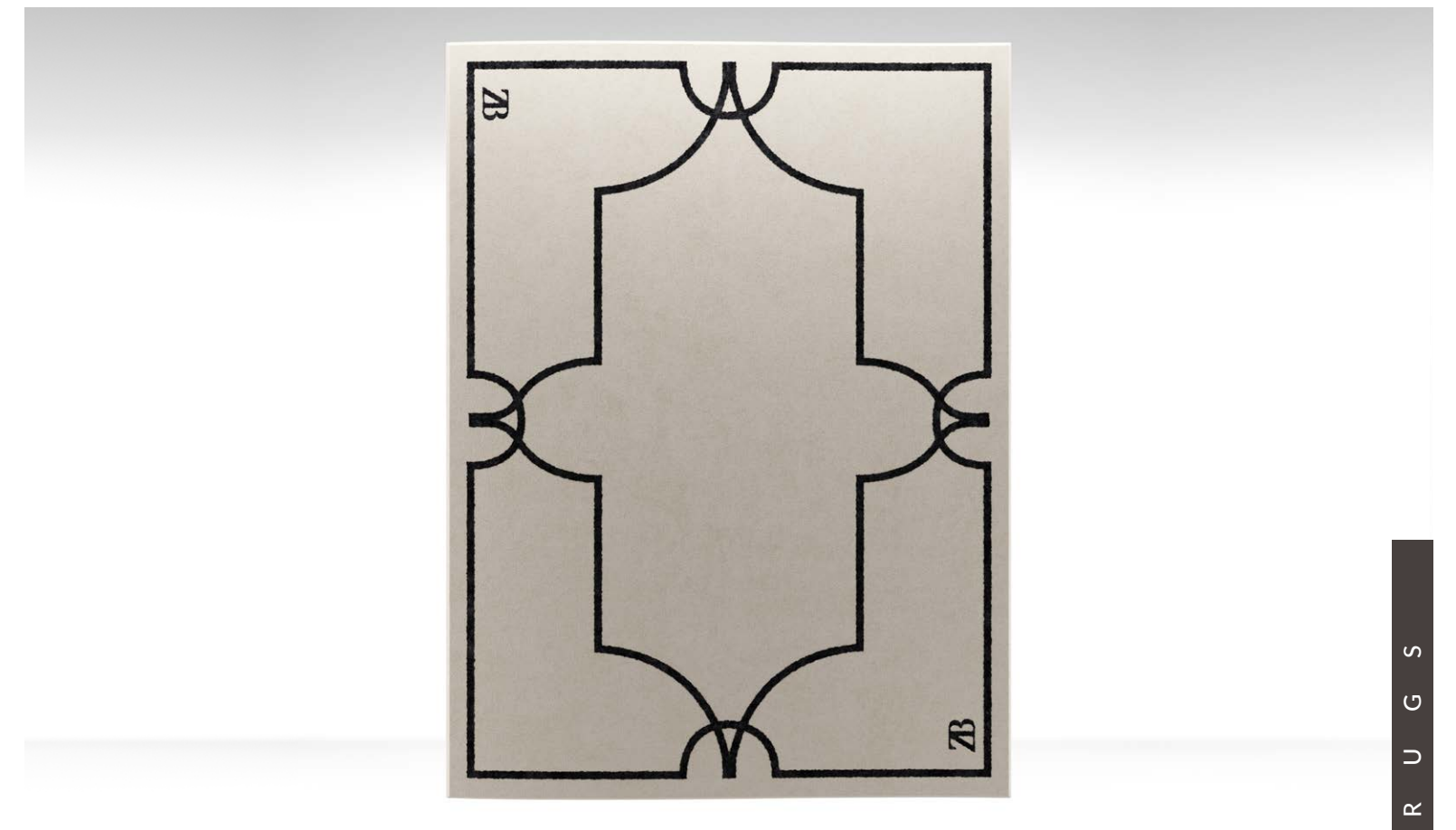

**As picture: Shirley rug**  
cm 400x300  
In price list: Prime

Tappeto/Rug/Ковер/地毯  
WOOL WHITE PEARL

Decorazione/Decoration/  
Декоративный элемент/装饰  
TENCEL BLACK

Tappeto "hand tufted" con disegno geometrico a contrasto. Composizione: 100% lana "New Zealand" con decoro in 100% Tencel. Disponibile con fondo bianco e disegno nero intenso.

Hand tufted rug with contrasting geometric pattern. 100% "New Zealand" wool with 100% Tencel decoration. Available in ivory/white color with black decoration.

Изготовленный вручную ковер с шитым ворсом, украшенный геометрическим рисунком контрастного цвета. 100%-я новозеландская шерсть, отделка из 100%-й ткани тенсел. Цвет слоновой кости / белый с черной отделкой.

手工植绒地毯，凸显对比的几何图案。100% 新西兰木料，100% Tencel 纤维装饰。象牙白/白色配黑色装饰。

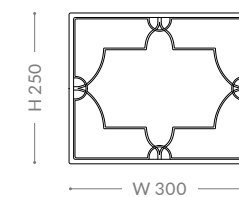

SHIRLEY cm 300x250

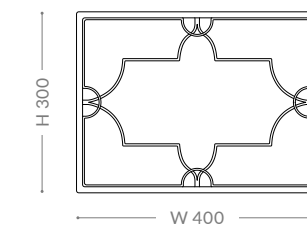

SHIRLEY cm 400x300

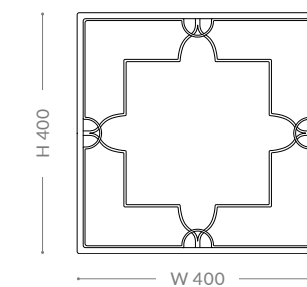

SHIRLEY cm 400x400

RUGS

# VERTIGO

RUG



RUGS

**As picture: Vertigo rug**  
cm 400x300  
In price list: Prime

Tappeto/Rug/Ковер/地毯  
WOOL TIFFANY  
TENCEL PEARL GREY  
TENCEL SILK GREY

Tappeto "hand tufted" con disegno astratto a contrasto. Composizione: 100% lana "New Zealand" per decoro e in 100% Tencel per fondo. Disponibile con disegno in 3 colori: tiffany, grigio perla e grigio seta.

Hand tufted rug with contrasting abstract pattern. 100% Tencel with 100% "New Zealand" wool decoration. Available in 3 colors pattern: tiffany, grey/pearl and satin grey.

Изготовленный вручную ковер с шитым ворсом, украшенный абстрактным рисунком контрастного цвета. 100%-я ткань тенсел, отделка из 100%-й новозеландской шерсти. Доступно с рисунком в 3 цветах: тиффани, серый/жемчужный и сатиновый серый.

手工植绒地毯，凸显对比的抽象图案。100% Tencel 纤维，100% 新西兰羊毛装饰。图案可选 3 种颜色：蒂芙尼蓝，灰色/珍珠色和缎面灰。

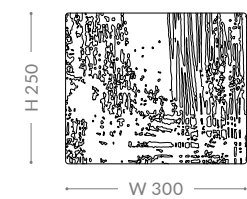

VERTIGO cm 300x250

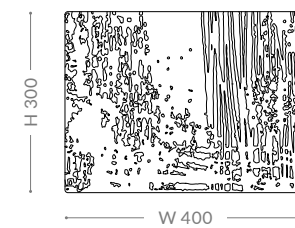

VERTIGO cm 400x300

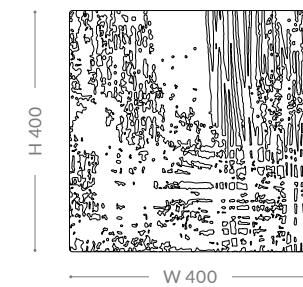

VERTIGO cm 400x400

# WAVE

RUG

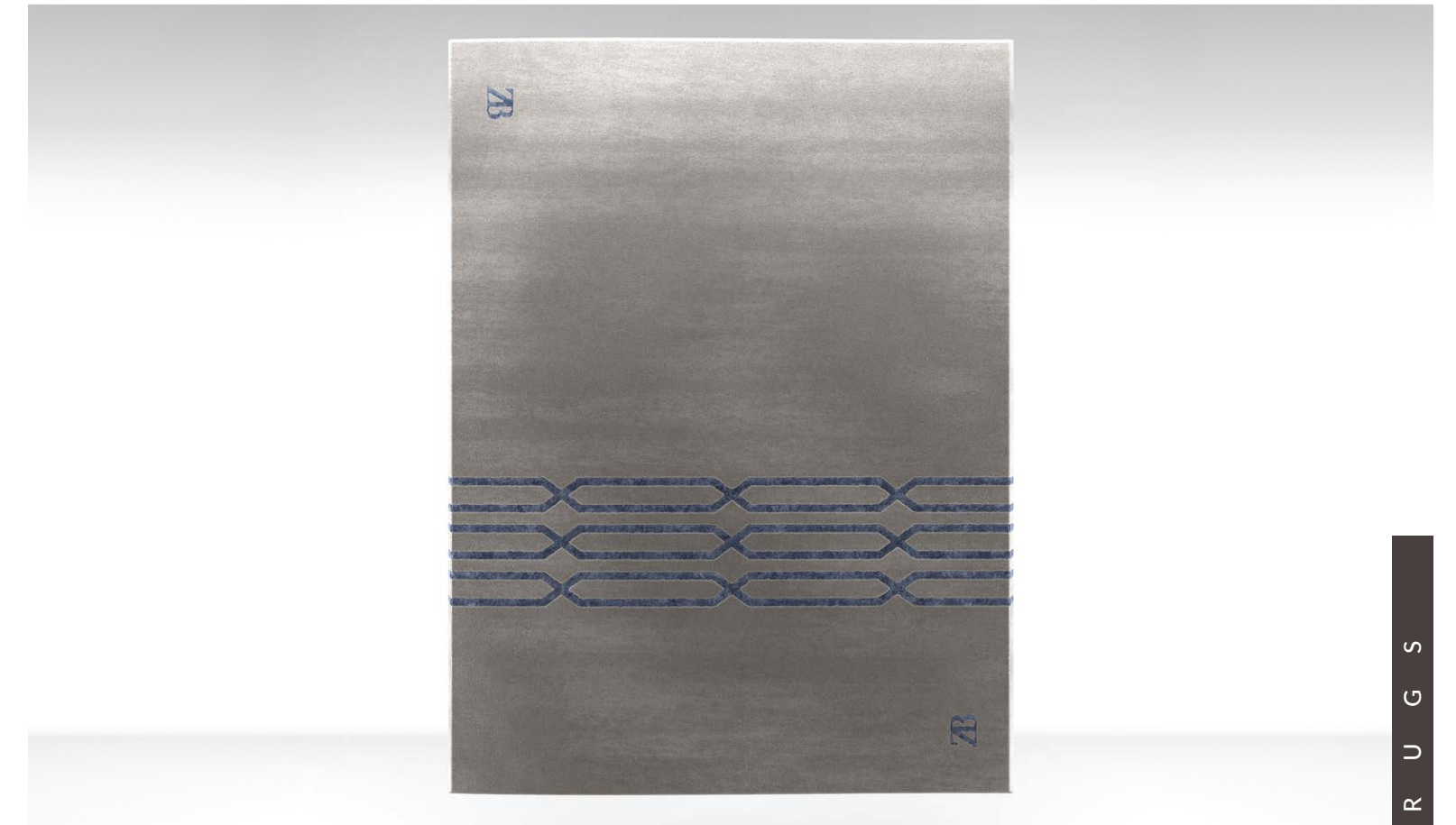

**As picture: Wave rug**  
cm 400x300  
In price list: Prime

Tappeto/Rug/Ковер/地毯  
TENCEL DOVE GREY

Decorazione/Decoration/  
Декоративный элемент/装饰  
TENCEL BLUE

Tappeto "hand tufted" con disegno "twin" a contrasto. Composizione: 100% Tencel. Disponibile con fondo color tortora e disegno color blu.

Hand tufted rug with contrasting "twin" pattern decoration. 100% Tencel. Available in dove-grey color with blue decoration.

Изготовленный вручную ковер с шитым ворсом, украшенный двойным рисунком контрастного цвета. 100%-я ткань тенсел. Голубовато-серый цвет, синяя отделка.

手工植绒地毯，点缀对称对比色图案。100% Tencel 纤维。鸽灰色配蓝色装饰。

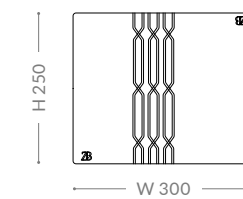

WAVE cm 300x250

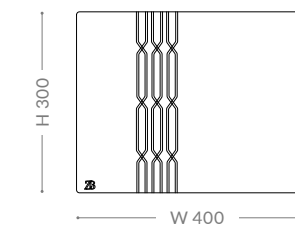

WAVE cm 400x300

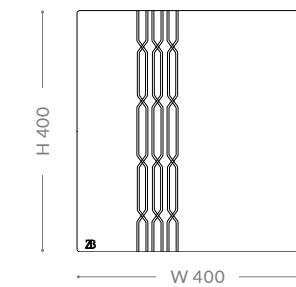

WAVE cm 400x400

RUGS



# ASTORIA

TABLE LAMP



LIGHTINGS

**As picture: Astoria table lamp**  
In price list: Prime

Parti in metallo/Metal parts/Металлическая фурнитура/金属部件  
SILK GOLD

Materiale/Material/Материал/材料  
BZ 905-5103 LEATHER LOBSTER

Lucidatura/Finishing/Отделка/饰面  
65. MAKASSAR

Struttura in metallo. Decorata con pannelli in legno laccato o in essenza di ebano makassar. Paralume in pelle ricamata.

Metal structure. Decorated with panels in lacquered wood or makassar ebony veneer. Quilted leather lampshade.

Металлический каркас. Отделка панелями из лакированной древесины или шпона макассарского эбена. Абажур из стеганой кожи.

金属结构。饰以漆木面板或孟加锡乌木饰面。绗缝皮革灯罩。

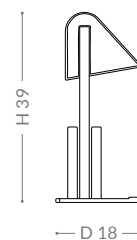
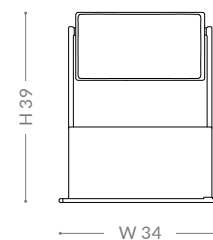

# ASTORIA

WALL LAMP

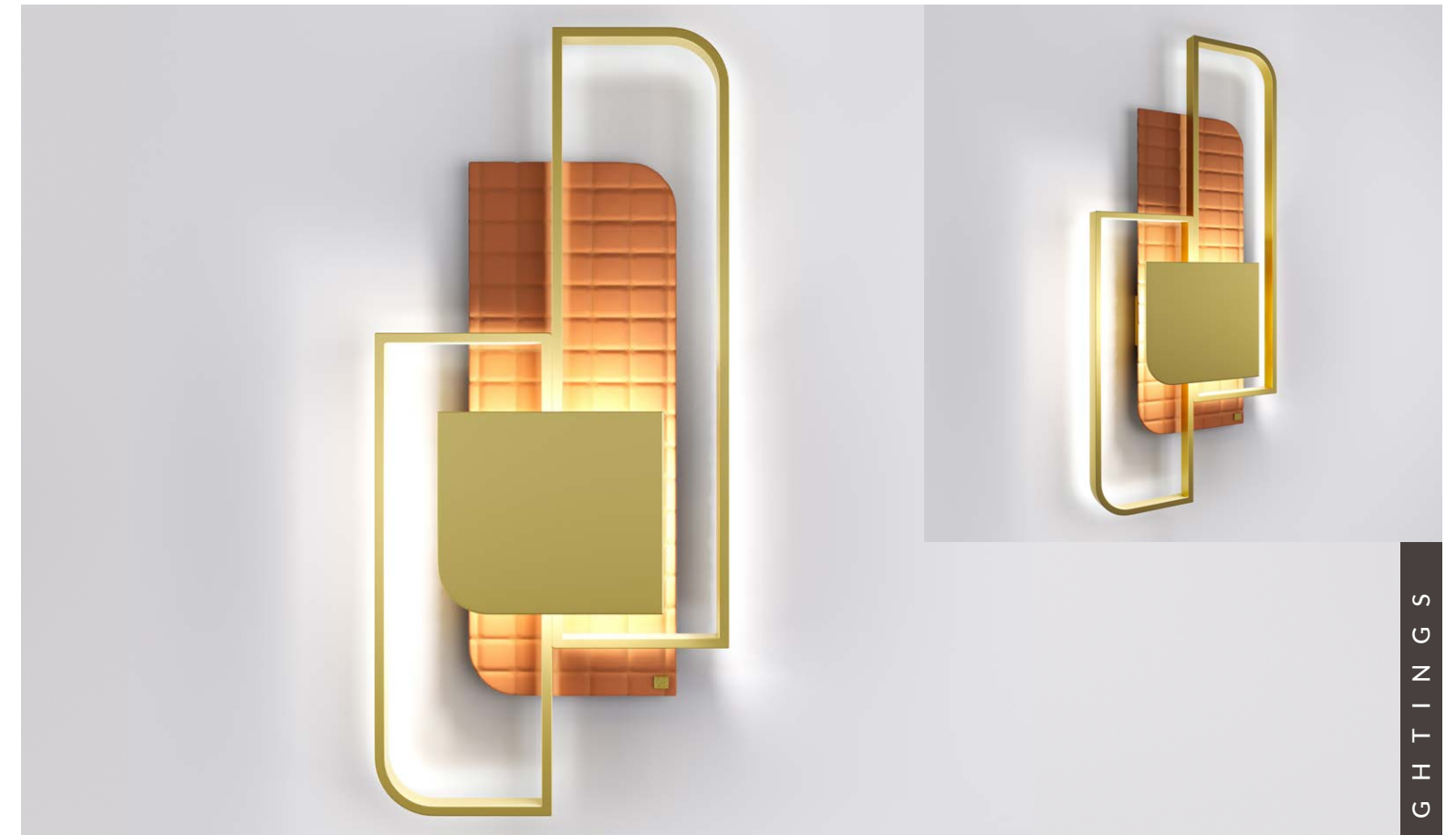

**As picture: Astoria wall lamp 100**  
In price list: Prime

Parti in metallo/Metal parts/Металлическая фурнитура/金属部件  
SILK GOLD

Materiale/Material/Материал/材料  
BZ 905-5103 LEATHER LOBSTER

Struttura in metallo. Decorata con pannello rivestito in pelle ricamata. Fornita con predisposizione attacco a parete.

Metal structure. Decorated with quilted leather panel. Equipped with wall fitting support.

Металлический каркас. Отделка в виде панели из стеганой кожи. Имеются элементы для настенного крепления.

金属结构。饰以绗缝皮革嵌条。配备墙壁安装支撑件。

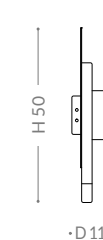
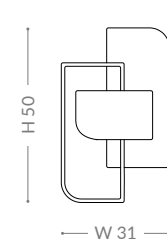

ASTORIA 50 wall lamp

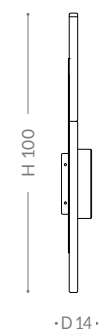
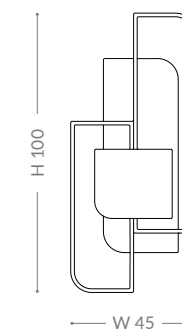

ASTORIA 100 wall lamp

LIGHTINGS



# BERNINI

TABLE LAMP



LIGHTINGS

**As picture: Bernini table lamp**  
In price list: Prime

Parti in metallo/Metal parts/Металлическая фурнитура/金属部件  
SILK TITANIUM

Materiale/Material/Материал/材料  
BZ 905-5234 LEATHER BEIGE  
BZ 184-901 PALMA BEIGE/IVORY

Struttura in metallo. Decorazione con formelle in pelle ricamata. Disponibile con paralume in tessuto.

Metal structure. Decorated with quilted leather tiles. Available with fabric lampshade.

Металлический каркас. Отделка в виде плиток из стеганой кожи. Тканевый абажур.

金属结构。块状绗缝皮革拼接点缀。布艺灯罩。

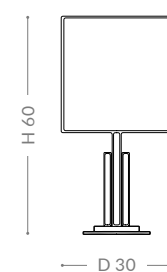
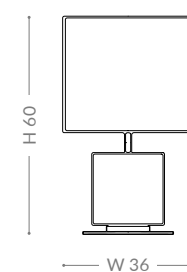

# TWIN

CHANDELIER



LIGHTINGS

**As picture: Twin chandelier 140**  
In price list: Prime

Parti in metallo/Metal parts/Металлическая фурнитура/金属部件  
TITANIUM

Vetro/Glass/Стеклоаное изделие/玻璃  
SATIN BRONZE

Decorazione del vetro/Glass decoration/Стеклоанный декоративный элемент/玻璃饰品  
WHITE

Struttura in metallo. Paralumi di forma geometrica color bronzo satinato. Decorazioni a catena in vetro rigato di Murano. Fornito con cavetti di acciaio e supporto per attacco a soffitto.

Metal structure. Geometric glass lampshades, satin bronze coloured. Murano grooved glass chain decorations. Equipped with steel wires and ceiling fitting support.

Металлический каркас. Геометрические стеклянные абажуры цвета сатинированной бронзы. Декоративные элементы цепочки из рифленого муранского стекла. Светильник имеет стальные провода и элементы для потолочного крепления.

金属结构。几何风格玻璃灯罩，缎面青铜色。慕拉诺凹纹玻璃链装饰。配有钢绳和天花板安装支撑件。

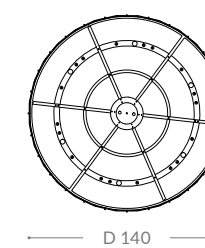
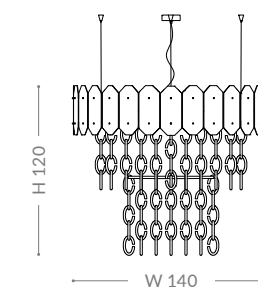

TWIN chandelier 140

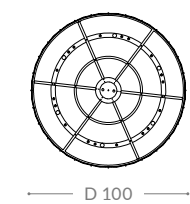
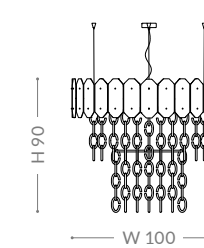

TWIN chandelier 100

# TWIN

RECTANGULAR CHANDELIER



LIGHTINGS

**As picture: Twin rectangular chandelier**  
In price list: Prime

Parti in metallo/Metal parts/Металлическая фурнитура/金属部件  
GOLD

Vetro/Glass/Стеклоанное изделие/玻璃  
SATIN BRONZE

Decorazione del vetro/Glass decoration/Стеклоанный декоративный элемент/玻璃饰品  
WHITE

Struttura in metallo. Paralumi di forma geometrica color bronzo satinato. Decorazioni a catena in vetro rigato di Murano. Fornito con cavetti di acciaio e supporto per attacco a soffitto.

Metal structure. Geometric glass lampshades, satin bronze coloured. Murano grooved glass chain decorations. Equipped with steel wires and ceiling fitting support.

Металлический каркас. Геометрические стеклянные абажуры цвета сатинированной бронзы. Декоративные элементы цепочки из рифленого муранского стекла. Светильник имеет стальные провода и элементы для потолочного крепления.

金属结构。几何风格玻璃灯罩，缎面青铜色。慕拉诺凹纹玻璃链装饰。配有钢绳和天花板安装支撑件。

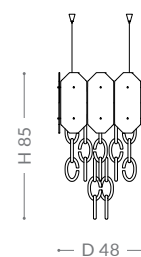
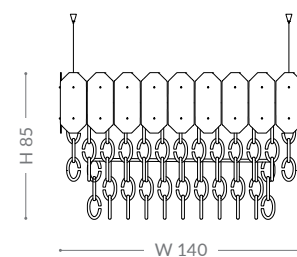

# TWIN

SUSPENSION LAMP



LIGHTINGS

**As picture: Twin suspension lamp**  
In price list: Prime

Parti in metallo/Metal parts/Металлическая фурнитура/金属部件  
GOLD

Vetro/Glass/Стеклоанное изделие/玻璃  
SATIN BRONZE  
SATIN WHITE

Struttura in metallo. Paralumi di forma geometrica color bronzo e bianco satinato. Fornito con cavetti di acciaio e supporto per attacco a soffitto.

Metal structure. Geometric glass lampshades, satin bronze and white colored. Equipped with steel wires and ceiling fitting support.

Металлический каркас. Стеклянные абажуры с геометрической отделкой по периметру в оттенке сатинированной бронзы и белом цвете. Светильник имеет стальные провода и элементы для потолочного крепления.

金属结构。几何轮廓玻璃灯罩，缎面青铜色和白色。配有钢绳和天花板安装支撑件。

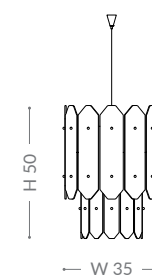

# TWIN

STANDING LAMP



LIGHTINGS

**As picture: Twin standing lamp**  
In price list: Prime

Parti in metallo/Metal parts/Металлическая фурнитура/金属部件  
TITANIUM

Vetro/Glass/Стеклоанное изделие/玻璃  
SATIN BRONZE  
SATIN WHITE

Struttura in metallo. Paralumi di forma geometrica color bronzo e bianco satinato.

Metal structure. Geometric glass lampshades, satin bronze and white colored.

Металлический каркас. Стекланные абажуры с геометрической отделкой в оттенке сатинированной бронзы и белом цвете.

金属结构。几何轮廓玻璃灯罩，缎面青铜色和白色。

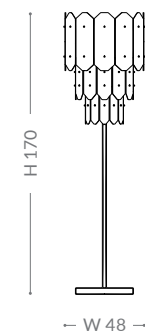

# TWIN

TABLE LAMP



LIGHTINGS

**As picture: Twin table lamp**  
In price list: Prime

Parti in metallo/Metal parts/Металлическая фурнитура/金属部件  
GOLD

Vetro/Glass/Стеклоанное изделие/玻璃  
SATIN BRONZE  
SATIN WHITE

Struttura in metallo. Paralumi di forma geometrica color bronzo e bianco satinato.

Metal structure. Geometric glass lampshades, satin bronze and white colored.

Металлический каркас. Стекланные абажуры с геометрической отделкой в оттенке сатинированной бронзы и белом цвете.

金属结构。几何轮廓玻璃灯罩，缎面青铜色和白色。

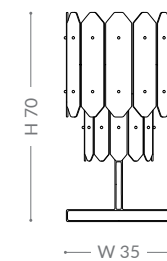

# TWIN

WALL LAMP



LIGHTINGS

**As picture: Twin wall lamp**  
In price list: Prime

Parti in metallo/Metal parts/Металлическая фурнитура/金属部件  
TITANIUM

Vetro/Glass/Стекло  
изделие/玻璃  
SATIN BRONZE

Struttura e telaio in metallo.  
Paralumi color bronzo satinato.  
Fornita con predisposizione  
attacco a parete.

Metal structure and frame.  
Satin bronze lampshades.  
Equipped with wall fitting  
support.

Металлические каркас  
и рама. Абажуры цвета  
сатирированной бронзы.  
Имеются элементы для  
настенного крепления.

金属结构和框架。缎面青铜灯  
罩。配备墙壁安装支撑件。

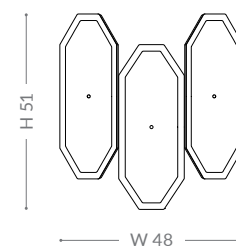

# WAVE

STANDING LAMP



**As picture: Wave standing lamp**  
In price list: Prime

Parti in metallo/Metal parts/Металлическая фурнитура/金属部件  
SILK GOLD

Materiale/Material/Материал/材料  
BZ 905-5234 LEATHER BEIGE  
BZ 184-901 PALMA BEIGE/IVORY

Struttura in metallo.  
Decorazioni in metallo curvato  
e formelle in pelle ricamata.  
Disponibile con paralume in  
tessuto.

Metal structure. Curved metal  
decoration and quilted leather  
panels. Available with fabric  
lampshade.

Металлический каркас.  
Резная металлическая  
отделка и панели из стеганой  
кожи. Тканевый абажур.

金属结构。曲线金属装饰，绗  
缝皮革嵌条。布艺灯罩。

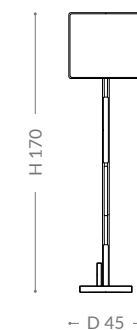
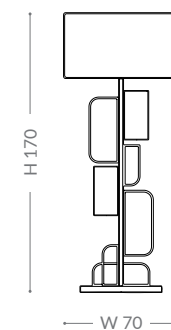

LIGHTINGS

# WAVE

TABLE LAMP

L I G H T I N G S



**As picture: Wave table lamp**  
In price list: Prime

Parti in metallo/Metal parts/Металлическая фурнитура/金属部件  
SILK GOLD

Materiale/Material/Материал/材料  
BZ 905-5234 LEATHER BEIGE  
BZ 184-901 PALMA BEIGE/IVORY

Struttura in metallo.  
Decorazioni in metallo curvato  
e formelle in pelle ricamata.  
Disponibile con paralume in  
tessuto.

Metal structure. Curved metal  
decoration and quilted leather  
panels. Available with fabric  
lampshade.

Металлический каркас.  
Резная металлическая  
отделка и панели из стеганой  
кожи. Тканевый абажур.

金属结构。曲线金属装饰，绗  
缝皮革嵌条。布艺灯罩。

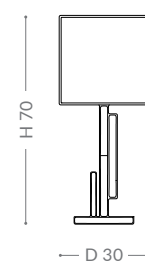
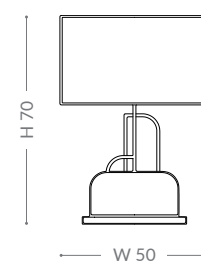



ZB

## SUMMARY



# SOFAS



**AMAZON** SOFA  
Vol. 1 - pag. 22



**AMBASSADOR** SOFA  
Vol. 1 - pag. 24



**AMBASSADOR** MODULAR SOFA  
Vol. 1 - pag. 26



**BABYLON** SOFA  
Vol. 1 - pag. 30



**GATSBY** SOFA  
Vol. 1 - pag. 56



**GIASONE** SOFA  
Vol. 1 - pag. 58



**GIASONE** MODULAR SOFA  
Vol. 1 - pag. 61



**GORDON** SOFA  
Vol. 1 - pag. 64



**BARRYMORE** SOFA  
Vol. 1 - pag. 32



**BARRYMORE** MODULAR SOFA  
Vol. 1 - pag. 34



**BAUHAUS** SOFA  
Vol. 1 - pag. 36



**BAUHAUS** SOFA  
Vol. 1 - pag. 38



**GORDON** MODULAR SOFA  
Vol. 1 - pag. 67



**HARMONY** SOFA  
Vol. 1 - pag. 70



**HEMINGWAY** SOFA  
Vol. 1 - pag. 72



**IPAZIA** SOFA  
Vol. 1 - pag. 74



**CLUB** SOFA  
Vol. 1 - pag. 40



**COCÒ** SOFA  
Vol. 1 - pag. 42



**DAVIS** SOFA  
Vol. 1 - pag. 44



**DAVIS** MODULAR SOFA  
Vol. 1 - pag. 46



**KING** SOFA  
Vol. 1 - pag. 76



**LEGEND** SOFA  
Vol. 1 - pag. 78



**LEGEND** SOFA  
Vol. 1 - pag. 80



**POSEIDON** SOFA  
Vol. 1 - pag. 82



**EMPERADOR** SOFA  
Vol. 1 - pag. 48



**EMPERADOR** SOFA  
Vol. 1 - pag. 50



**FLY** SOFA  
Vol. 1 - pag. 52



**GATSBY** SOFA  
Vol. 1 - pag. 54



**POSEIDON** SOFA  
Vol. 1 - pag. 84



**VERTIGO** SOFA  
Vol. 1 - pag. 86



**VERTIGO** SOFA  
Vol. 1 - pag. 88



**WAVE** SOFA  
Vol. 1 - pag. 90



**WAVE** MODULAR SOFA  
Vol. 1 - pag. 93

# ARMCHAIRS



**CLUB WIDE** ARMCHAIR  
Vol. 1 - pag. 114



**DAVIS** ARMCHAIR  
Vol. 1 - pag. 116



**DAVIS SMALL** ARMCHAIR  
Vol. 1 - pag. 118



**FLOWER** ARMCHAIR  
Vol. 1 - pag. 120



**FLY** ARMCHAIR  
Vol. 1 - pag. 122



**IPAZIA** ARMCHAIR  
Vol. 1 - pag. 124



**IPAZIA** ARMCHAIR  
Vol. 1 - pag. 126



**KING** ARMCHAIR  
Vol. 1 - pag. 128



**ARDEA** ARMCHAIR  
Vol. 1 - pag. 98



**ARDEA** ARMCHAIR  
Vol. 1 - pag. 100



**ARIEL** ARMCHAIR  
Vol. 1 - pag. 102



**AURORA** ARMCHAIR  
Vol. 1 - pag. 104



**LEGEND** ARMCHAIR  
Vol. 1 - pag. 130



**LEGEND** ARMCHAIR  
Vol. 1 - pag. 132



**LOPEZ** ARMCHAIR  
Vol. 1 - pag. 134



**MARYLOU** ARMCHAIR  
Vol. 1 - pag. 136



**BAUHAUS** ARMCHAIR  
Vol. 1 - pag. 106



**BEVERLY** ARMCHAIR  
Vol. 1 - pag. 108



**BEVERLY** ARMCHAIR  
Vol. 1 - pag. 110



**CLUB** ARMCHAIR  
Vol. 1 - pag. 112



**MARYLOU** ARMCHAIR  
Vol. 1 - pag. 138



**PANDORA** ARMCHAIR  
Vol. 1 - pag. 140



**PANDORA** ARMCHAIR  
Vol. 1 - pag. 142



**WALLY** ARMCHAIR  
Vol. 1 - pag. 144



## DORMEUSE



**COLETTE** DORMEUSE  
Vol. 1 - pag. 148



**GERRIT** DORMEUSE  
Vol. 1 - pag. 150



**GORDON** DORMEUSE  
Vol. 1 - pag. 152



**LEGEND** DORMEUSE  
Vol. 1 - pag. 154

## POUFS



**ADAM** POUF  
Vol. 1 - pag. 158

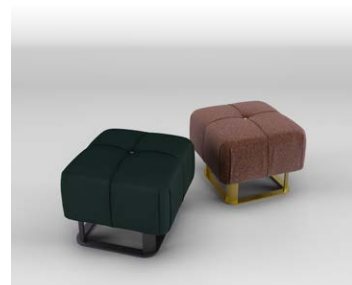

**BELLE** POUF  
Vol. 1 - pag. 159



**FLY** POUF  
Vol. 1 - pag. 160



**FLY CAPITONNÉ** POUF  
Vol. 1 - pag. 161



**KIMBERLY** POUF  
Vol. 1 - pag. 162



**MOON WALT** POUF  
Vol. 1 - pag. 163

## SOFA TABLES



**ALCESTE** SIDE TABLE  
Vol. 1 - pag. 166



**CLUB** CENTRAL TABLE  
Vol. 1 - pag. 167



**CLUB** SIDE TABLE  
Vol. 1 - pag. 168



**DEA** SIDE TABLE  
Vol. 1 - pag. 169



**DEA** TWIN SET  
Vol. 1 - pag. 170



**ESEDRA** SIDE TABLE  
Vol. 1 - pag. 171



**ESEDRA** CENTRAL TABLE SET  
Vol. 1 - pag. 172



**EXPERIA** CENTRAL TABLE  
Vol. 1 - pag. 173



**FLY** CENTRAL TABLE  
Vol. 1 - pag. 174



**FLY** SIDE TABLE  
Vol. 1 - pag. 175

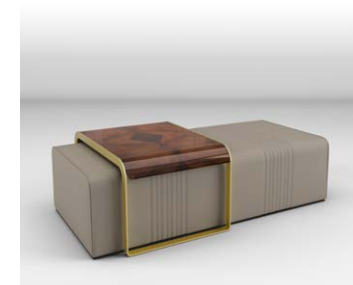

**GREY** TABLE SET  
Vol. 1 - pag. 176



**HECTOR** SIDE TABLE  
Vol. 1 - pag. 177



**MUMFORD** CENTRAL TABLE  
Vol. 1 - pag. 178



**MUMFORD** SIDE TABLE  
Vol. 1 - pag. 179



**NEW LINE** RECTANGULAR CENTRAL TABLE  
Vol. 1 - pag. 180



**NEW LINE** SQUARE CENTRAL TABLE  
Vol. 1 - pag. 181



**NEW LINE** SIDE TABLE  
Vol. 1 - pag. 182



**NEW LINE** SIDE TABLE  
Vol. 1 - pag. 183



**OLIVER** CENTRAL TABLE  
Vol. 1 - pag. 184



**OLIVER** SIDE TABLE  
Vol. 1 - pag. 185



**TRITON** ROUND TABLE 45  
Vol. 1 - pag. 199



**TRITON** ROUND TABLE 60  
Vol. 1 - pag. 200



**TRITON** COURTESY TABLE  
Vol. 1 - pag. 201



**TULIP** ROUND TABLE  
Vol. 1 - pag. 202



**OLIVER** COURTESY TABLE  
Vol. 1 - pag. 186



**OTTO** CENTRAL TABLE  
Vol. 1 - pag. 187



**OTTO** CENTRAL TABLE  
Vol. 1 - pag. 188



**RUPERT** CENTRAL TABLE  
Vol. 1 - pag. 189



**TULIP** SIDE TABLE 35+45  
Vol. 1 - pag. 203



**TULIP** TRIS SET  
Vol. 1 - pag. 204

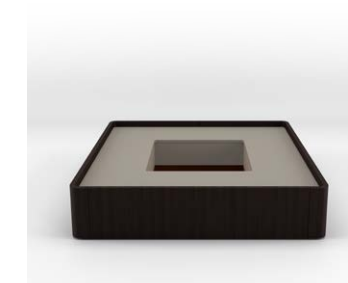

**WAVE** CENTRAL TABLE  
Vol. 1 - pag. 205

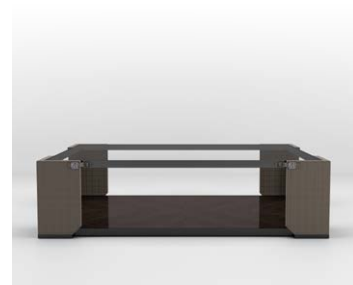

**RUPERT** CENTRAL TABLE  
Vol. 1 - pag. 190



**RUPERT** ROUND TABLE  
Vol. 1 - pag. 191



**RUPERT** ROUND TABLE  
Vol. 1 - pag. 192



**STAN** CENTRAL TABLE  
Vol. 1 - pag. 193



**STAN** COURTESY TABLE  
Vol. 1 - pag. 194



**STAN** SIDE TABLE  
Vol. 1 - pag. 195



**TRITON** CENTRAL TABLE  
Vol. 1 - pag. 196



**TRITON** SQUARE TABLE  
Vol. 1 - pag. 198

# DINING TABLES



**BOSTON** RECTANGULAR DINING TABLE  
Vol. 1 - pag. 208



**BOSTONWIDE** RECTANGULAR DINING TABLE  
Vol. 1 - pag. 210



**BOSTON** ROUND DINING TABLE  
Vol. 1 - pag. 212



**GILLON** EXTENSIBLE DINING TABLE  
Vol. 1 - pag. 214



**PETRUS** RECTANGULAR DINING TABLE  
Vol. 1 - pag. 240



**PETRUS** ROUND DINING TABLE  
Vol. 1 - pag. 242



**PETRUS** ROUND DINING TABLE  
Vol. 1 - pag. 244



**WANDA** RECTANGULAR DINING TABLE  
Vol. 1 - pag. 246



**MANHATTAN** RECTANGULAR DINING TABLE  
Vol. 1 - pag. 216



**METROPOLIS** ELLIPTICAL DINING TABLE  
Vol. 1 - pag. 218



**METROPOLISWIDE** ELLIPTICAL DINING TABLE  
Vol. 1 - pag. 220



**METROPOLIS** ROUND DINING TABLE  
Vol. 1 - pag. 222

# DINING CHAIRS



**MILLENIUM** ROUND DINING TABLE  
Vol. 1 - pag. 224



**MILLENIUM** RECTANGULAR DINING TABLE  
Vol. 1 - pag. 226



**OMEGA** CRYSTAL RECTANGULAR DINING TABLE  
Vol. 1 - pag. 228



**OMEGA** EBONY RECTANGULAR DINING TABLE  
Vol. 1 - pag. 230



**ARISTON** DINING CHAIR  
Vol. 1 - pag. 250



**ARISTON** DINING CHAIR  
Vol. 1 - pag. 251



**CAPRICE** DINING ARMCHAIR  
Vol. 1 - pag. 252



**CAPRICE** DINING CHAIR  
Vol. 1 - pag. 253



**OMEGA** CRYSTAL ROUND DINING TABLE  
Vol. 1 - pag. 232



**OMEGA** EBONY ROUND DINING TABLE  
Vol. 1 - pag. 234



**ORION** ROUND DINING TABLE  
Vol. 1 - pag. 236



**ORION** RECTANGULAR DINING TABLE  
Vol. 1 - pag. 238



**CELINE** DINING ARMCHAIR  
Vol. 1 - pag. 254



**CELINE** DINING CHAIR  
Vol. 1 - pag. 255



**DILETTA** DINING ARMCHAIR  
Vol. 1 - pag. 256



**DILETTA** DINING ARMCHAIR  
Vol. 1 - pag. 257

## BAR COUNTERS AND STOOLS



**DILETTA** DINING CHAIR  
Vol. 1 - pag. 258



**DILETTA** DINING CHAIR  
Vol. 1 - pag. 259



**GRETA** DINING ARMCHAIR  
Vol. 1 - pag. 260



**GRETA** DINING CHAIR  
Vol. 1 - pag. 261



**DIONISO** BAR COUNTER  
Vol. 1 - pag. 276



**LEGEND** BAR COUNTER  
Vol. 1 - pag. 278



**ARISTON** BAR STOOL  
Vol. 1 - pag. 280



**FLOWER** BAR STOOL  
Vol. 1 - pag. 281



**MARYBELL** DINING ARMCHAIR  
Vol. 1 - pag. 262



**MARYBELL** DINING ARMCHAIR  
Vol. 1 - pag. 263



**OPHELIA** DINING ARMCHAIR  
Vol. 1 - pag. 264



**OPHELIA** DINING ARMCHAIR  
Vol. 1 - pag. 265



**OPHELIA** BAR STOOL  
Vol. 1 - pag. 282



**OPHELIA** BAR TABLE  
Vol. 1 - pag. 283



**OPHELIA** DINING CHAIR  
Vol. 1 - pag. 266



**OPHELIA** DINING CHAIR  
Vol. 1 - pag. 267



**OPIUM** DINING ARMCHAIR  
Vol. 1 - pag. 268



**OPIUM** DINING CHAIR  
Vol. 1 - pag. 269



**SUNRISE** DINING ARMCHAIR  
Vol. 1 - pag. 270



**SUNRISE** DINING CHAIR  
Vol. 1 - pag. 271



**VERSAILLE** DINING ARMCHAIR  
Vol. 1 - pag. 272



**VERSAILLE** DINING CHAIR  
Vol. 1 - pag. 273

# BEDS



**APOLLO** BED  
Vol. 2 - pag. 22



**BERNINI** BED  
Vol. 2 - pag. 24



**BERNINI WIDE** BED  
Vol. 2 - pag. 26



**BERNINI XYLO** BED  
Vol. 2 - pag. 28



**BERNINI XYLO WIDE** BED  
Vol. 2 - pag. 30



**CLEO** BED  
Vol. 2 - pag. 32



**HERMES** BED  
Vol. 2 - pag. 34



**HERMITAGE** BED  
Vol. 2 - pag. 36



**HORIZON** BED  
Vol. 2 - pag. 38



**JUNO** BED  
Vol. 2 - pag. 40



**KING** BED  
Vol. 2 - pag. 42



**MADISON** BED  
Vol. 2 - pag. 44



**OCEAN** BED  
Vol. 2 - pag. 46



**OVERWALL** BED  
Vol. 2 - pag. 48

# BEDSIDE TABLES



**BUSTER** BEDSIDE TABLE  
Vol. 2 - pag. 52



**CLARK** BEDSIDE TABLE  
Vol. 2 - pag. 53



**ELYPSE** BEDSIDE TABLE  
Vol. 2 - pag. 54



**ELYPSE** BEDSIDE TABLE  
Vol. 2 - pag. 55



**GLENN** BEDSIDE TABLE  
Vol. 2 - pag. 56



**HERMES** BEDSIDE TABLE  
Vol. 2 - pag. 57



**HORIZON** BEDSIDE TABLE  
Vol. 2 - pag. 58



**OCEAN I** BEDSIDE TABLE  
Vol. 2 - pag. 59



**OCEAN II** BEDSIDE TABLE  
Vol. 2 - pag. 60



**REMINGTON** BEDSIDE TABLE  
Vol. 2 - pag. 61



**STUART** BEDSIDE TABLE  
Vol. 2 - pag. 62



**STUART** BEDSIDE TABLE  
Vol. 2 - pag. 63

## CHEST OF DRAWERS



**BUSTER** CHEST OF DRAWERS  
Vol. 2 - pag. 66



**BUSTER** CHEST OF DRAWERS  
Vol. 2 - pag. 68



**DEANNA** CHEST OF DRAWERS  
Vol. 2 - pag. 70



**GLENN** CHEST OF DRAWERS  
Vol. 2 - pag. 72



**REMINGTON** CHEST OF DRAWERS  
Vol. 2 - pag. 74

## DRESSING TABLES



**EMANUELLE** DRESSING TABLE  
Vol. 2 - pag. 78



**KIMBERLY** DRESSING TABLE  
Vol. 2 - pag. 80



**KIMBERLY** POUF  
Vol. 2 - pag. 81



**MADEMOISELLE** DRESSING TABLE  
Vol. 2 - pag. 82



**MADEMOISELLE** CHAIR  
Vol. 2 - pag. 84



**VIVIEN** DRESSING TABLE  
Vol. 2 - pag. 86



**MOON WALT** POUF  
Vol. 2 - pag. 87

## BENCHES



**ADAM** BENCH  
Vol. 2 - pag. 90



**BLANGA** BENCH 100  
Vol. 2 - pag. 91



**BLANGA** BENCH 160  
Vol. 2 - pag. 92



**FAYR** BENCH  
Vol. 2 - pag. 93



**FLY** BENCH  
Vol. 2 - pag. 94



**GREY** BENCH  
Vol. 2 - pag. 95



**HERMES** BENCH  
Vol. 2 - pag. 96



**MOON WALT** BENCH  
Vol. 2 - pag. 97

## CONSOLLES



**KIMBERLY** CONSOLLE  
Vol. 2 - pag. 100



**KIMBERLY** CONSOLLE SMALL  
Vol. 2 - pag. 102



**LUCINDA** CONSOLLE  
Vol. 2 - pag. 104



**LUCINDA** CONSOLLE  
Vol. 2 - pag. 106



**RANDOLPH** CONSOLLE  
Vol. 2 - pag. 108



**SWING** BACKSOFA CONSOLLE  
Vol. 2 - pag. 110



**SWING** CONSOLLE LARGE  
Vol. 2 - pag. 112



**SWING** CONSOLLE SMALL  
Vol. 2 - pag. 114



**WANDA** CONSOLLE  
Vol. 2 - pag. 116



**WANDA** CONSOLLE SMALL  
Vol. 2 - pag. 118

## SIDEBOARDS



**CONCORDE** SIDEBOARD  
Vol. 2 - pag. 122



**CONCORDE** SIDEBOARD WIDE  
Vol. 2 - pag. 124



**DEANNA** SIDEBOARD 9 DRAWERS  
Vol. 2 - pag. 126



**DEANNA** SIDEBOARD 3 DRAWERS  
Vol. 2 - pag. 128



**DUKE** SIDEBOARD  
Vol. 2 - pag. 130



**FIORILE** SIDEBOARD  
Vol. 2 - pag. 132



**GLENN** SIDEBOARD HIGH  
Vol. 2 - pag. 134



**GLENN** SIDEBOARD LOW  
Vol. 2 - pag. 136



**REMINGTON** SIDEBOARD  
Vol. 2 - pag. 138

## TV UNITS



**CONCORDE** TV FRAME  
Vol. 2 - pag. 142



**CONCORDE** TV CABINET  
Vol. 2 - pag. 144



**DUCA** TV FRAME  
Vol. 2 - pag. 146



**DUCA** TV CABINET  
Vol. 2 - pag. 148



**DUKE** TV FRAME  
Vol. 2 - pag. 150



**DUKE** TV CABINET  
Vol. 2 - pag. 152



**FIORILE** TV CABINET  
Vol. 2 - pag. 154



**REMINGTON** TV FRAME  
Vol. 2 - pag. 156



**REMINGTON** TV CABINET  
Vol. 2 - pag. 158

## DISPLAY CABINETS



**CONCORDE** DISPLAY CABINET  
Vol. 2 - pag. 162



**ESTELLE** DISPLAY CABINET  
Vol. 2 - pag. 164



**ESTELLE** DISPLAY CABINET  
Vol. 2 - pag. 166



**FRITZ** DISPLAY CABINET  
Vol. 2 - pag. 168



**KIMBERLY** DISPLAY CABINET  
Vol. 2 - pag. 170



**VENUS** DISPLAY CABINET  
Vol. 2 - pag. 172

## BOOKSHELVES



**CLARK** BOOKSHELF  
Vol. 2 - pag. 176



**DAFNE** BOOKSHELF  
Vol. 2 - pag. 178



**JADE** BOOKSHELF  
Vol. 2 - pag. 180



**SIRIO** BOOKSHELF  
Vol. 2 - pag. 182



# CABINETS



**CONCORDE** WARDROBE CABINET  
Vol. 2 - pag. 186



**CONCORDE** WINE CABINET  
Vol. 2 - pag. 188



**DEDALO** BACK SOFA CABINET  
Vol. 2 - pag. 191



**DEDALO** CABINET  
Vol. 2 - pag. 192



**RICHELIEU** BAR CABINET  
Vol. 2 - pag. 206



**RICHELIEU** GAMING CABINET  
Vol. 2 - pag. 208



**VENUS** CABINET  
Vol. 2 - pag. 210



**DEDALO** DUAL UNIT  
Vol. 2 - pag. 193



**DEDALO** FREE STANDING PARTITION 1  
Vol. 2 - pag. 194



**DEDALO** FREE STANDING PARTITION 2  
Vol. 2 - pag. 195



**DEDALO** LIBRARY  
Vol. 2 - pag. 196

# DESKS

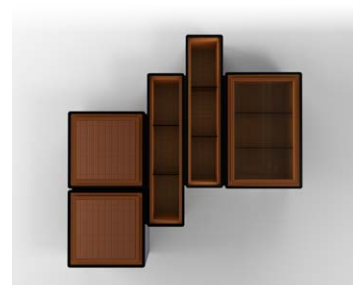

**DEDALO** OFFICE COMPOSITION  
Vol. 2 - pag. 197



**DEDALO** SIDEBOARD  
Vol. 2 - pag. 198



**DEDALO** TV CABINET 1  
Vol. 2 - pag. 199



**DEDALO** TV COMPOSITION 1  
Vol. 2 - pag. 200



**ASTORIA** DESK  
Vol. 2 - pag. 214



**CLARK** DESK  
Vol. 2 - pag. 216



**LEGEND** DESK  
Vol. 2 - pag. 218



**SQUARE** DESK  
Vol. 2 - pag. 220



**DEDALO** TV COMPOSITION 2  
Vol. 2 - pag. 201



**DEDALO** TV COMPOSITION 3  
Vol. 2 - pag. 202

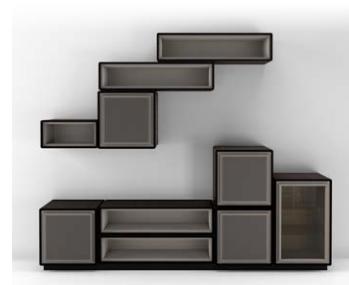

**DEDALO** WALL COMPOSITION  
Vol. 2 - pag. 203



**FRITZ** BAR CABINET  
Vol. 2 - pag. 204

## OFFICE CHAIRS



**ATLANTIS** OFFICE CHAIR  
Vol. 2 - pag. 224



**COMET** FRONT DESK CHAIR  
Vol. 2 - pag. 225



**COMET** OFFICE CHAIR  
Vol. 2 - pag. 226



**LONDON** OFFICE CHAIR  
Vol. 2 - pag. 227



**REGENT** FRONT DESK CHAIR  
Vol. 2 - pag. 228



**REGENT** OFFICE CHAIR  
Vol. 2 - pag. 229

## MIRRORS

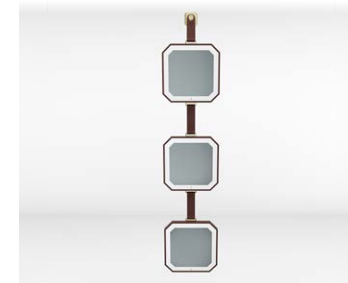

**ARTEMIDE** MIRROR  
Vol. 2 - pag. 232

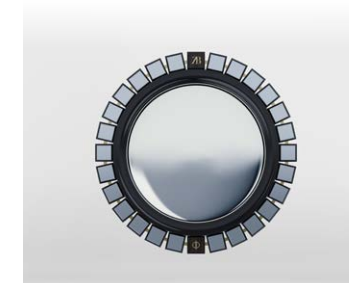

**CONSTANCE** MIRROR  
Vol. 2 - pag. 233



**ETIENNE** MIRROR  
Vol. 2 - pag. 234

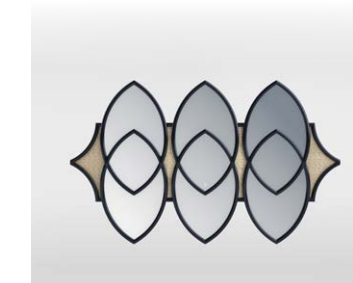

**FLYNN** MIRROR  
Vol. 2 - pag. 235



**IKE** MIRROR  
Vol. 2 - pag. 236



**JUPITER** MIRROR  
Vol. 2 - pag. 237



**OSIRIS** RECTANGULAR MIRROR  
Vol. 2 - pag. 238



**OSIRIS** ROUND MIRROR  
Vol. 2 - pag. 239



**SHIRLEY** MIRROR  
Vol. 2 - pag. 240



**TWIN** MIRROR  
Vol. 2 - pag. 241



**TWIN** MIRRORS COMPOSITION 1  
Vol. 2 - pag. 242

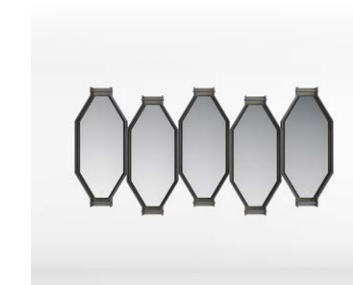

**TWIN** MIRRORS COMPOSITION 2  
Vol. 2 - pag. 243

## DECORATIONS



**ARES** PANELING  
Vol. 2 - pag. 246



**BAUHAUS** COLUMN  
Vol. 2 - pag. 248



**CLUB** COLUMN  
Vol. 2 - pag. 249



**EOLO** SAIL  
Vol. 2 - pag. 250



**LEONE** WOOD SCREEN  
Vol. 2 - pag. 252



**ODISSEY** SCREEN  
Vol. 2 - pag. 254

## RUGS



**AMBASSADOR** RUG  
Vol. 2 - pag. 258



**ASTORIA** RUG  
Vol. 2 - pag. 259



**CLUB** CARVED RUG  
Vol. 2 - pag. 260



**OCEAN** RUG  
Vol. 2 - pag. 261



**PETRUS** RUG  
Vol. 2 - pag. 262

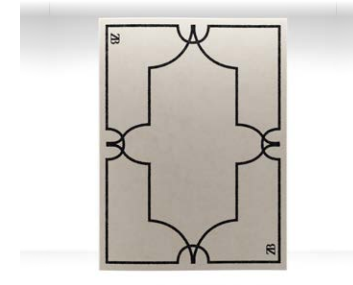

**SHIRLEY** RUG  
Vol. 2 - pag. 263



**VERTIGO** RUG  
Vol. 2 - pag. 264



**WAVE** RUG  
Vol. 2 - pag. 265

# LIGHTINGS



ASTORIA TABLE LAMP  
Vol. 2 - pag. 268

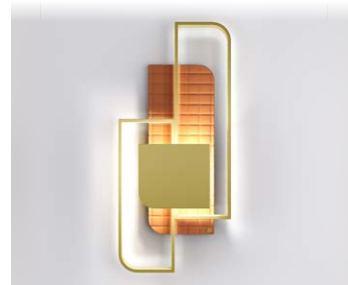

ASTORIA WALL LAMP  
Vol. 2 - pag. 269



BERNINI TABLE LAMP  
Vol. 2 - pag. 270



TWIN CHANDELIER  
Vol. 2 - pag. 271



TWIN RECTANGULAR CHANDELIER  
Vol. 2 - pag. 272



TWIN SUSPENSION LAMP  
Vol. 2 - pag. 273



TWIN STANDING LAMP  
Vol. 2 - pag. 274



TWIN TABLE LAMP  
Vol. 2 - pag. 275



TWIN WALL LAMP  
Vol. 2 - pag. 276



WAVE STANDING LAMP  
Vol. 2 - pag. 277



WAVE TABLE LAMP  
Vol. 2 - pag. 278

CONTACT US

**BRUNO ZAMPA s.r.l.**

Via Crosaron, 23  
37053 Cerea  
Verona - Italy  
T. +39 0442 80594  
F. +39 0442 329534

**GALLERY**

Via Calcara 68/70  
37053 Cerea  
Verona - Italy

[info@brunozampa.it](mailto:info@brunozampa.it)  
[www.brunozampa.it](http://www.brunozampa.it)

Produced by  
©Bruno Zampa s.r.l. - All rights reserved

PHOTO Lighthug Design s.r.l. and Place Design e Rendering s.r.l.s.

GRAPHIC DESIGN Deepartweb s.r.l.

PRINTING Grafiche Stella s.r.l.

All products in this catalogue are 100% Made in Italy.

All colors of leather or fabric's covers, lacquered wood and rugs can't be considered as color references.

The dimensions of products are subject to change according to the instructions of the catalogue.

Any reproduction, representation or modification, in full or partly, is expressly prohibited.





[www.brunozampa.it](http://www.brunozampa.it)